



PILOT'S OPERATING HANDBOOK

VELIS Electro

Document No.: POH-128-00-40-001

REVISION B00

Date of Issue: June 10th, 2020

Signature: _____

Registration: _____

Serial No.: _____

All rights reserved. Reproduction or disclosure to third parties of this document or any part thereof is not permitted, except with the prior and express written permission of Pipistrel Group's R&D division, Pipistrel Vertical Solutions d.o.o., which is authorized to publish technical documentation for Pipistrel Group's subsidiaries.



Pilot's Operating Handbook



Aircraft type:	Virus SW 121
Model:	Virus SW 128
T.C. no.:	EASA.A.573
Type certificate holder:	PIPISTREL VERTICAL SOLUTIONS d.o.o. Vipavska cesta 2 SI-5270 Ajdovščina Slovenia Tel: + 386 5 36 63 873 Fax: + 386 5 36 61 263 Email: info@pipistrel.si

This handbook includes all of the material required to be provided to the pilot by CS-LSA regulations. Additional information, deemed necessary by the TC holder, is also included.

Those pages marked as “APPROVED” are approved by the European Aviation Safety Agency.

The airplane must be operated in compliance with information and limitations contained herein.



Table of contents

SECTION	CONTENTS
0	FOREWORD
1	GENERAL
2	LIMITATIONS
3	EMERGENCY PROCEDURES
4	NORMAL PROCEDURES
5	PERFORMANCE DATA
6	WEIGHT AND BALANCE
7	AIRPLANE DESCRIPTION
8	HANDLING AND SERVICING
9	APPENDIX



USING THIS HANDBOOK

Special statements in the Pilot's Operating Handbook/Airplane Flight Manual concerning the safety or operation of the airplane are highlighted by being prefixed by one of the following terms:

WARNING: Means that the non-observance of the corresponding procedures lead to an immediate or significant degradation in flight safety.

CAUTION: Means that the non-observance of the corresponding procedures leads to a minor or to a long term degradation of the flight safety.

NOTE: Draws the attention to any special item not directly related to safety but which is important or unusual.

Revision tracking, filing and identifying

Pages to be removed or replaced in this pilot's operating handbook (POH) are determined by the log of effective pages located in this section. This log contains the page number and revision number for each page within the POH. As revisions to the POH occur, the revision number on the affected pages is updated and the page number in the log is highlighted with bold font type. When two pages display the same page number, the page with the latest revision shall be used in the POH.

The revision number on the log of effective pages shall also coincide with the revision number of the page in question. As an alternative to removing and/or replacing individual pages, the owner can also print out a whole new manual in its current form.

Revised material is marked with a vertical bar that will extend the full length of deleted, new or revised text added to new or previously existing pages. This marker will be located adjacent to the applicable text in the marking on the outer side of the page. The same system applies when the header, figure or any other element inside this POH is revised. A list of revisions is located at the beginning of the log of effective pages. Pipistrel is not responsible for technical changes/updates to OEM manuals supplied with the aircraft (e.g. radio, transponder, GPS, etc.).



Index of document revisions

Doc. Rev.	Reason for revision	Affected pages	Authority
B00	Initial	ALL	EASA 10.06.2020



List of effective pages

PAGE NUMBER	PAGE REV.	PAGE NUMBER	PAGE REV.	PAGE NUMBER	PAGE REV.	PAGE NUMBER	PAGE REV.
Cover	-	2 - 1	0	3 - 1	0	3 - 35	0
ii	0	2 - 2	0	3 - 2	0	3 - 36	0
iii	0	2 - 3	0	3 - 3	0	3 - 37	0
iv	0	2 - 4	0	3 - 4	blank	3 - 38	0
v	0	2 - 5	0	3 - 5	0	3 - 39	0
vi	0	2 - 6	0	3 - 6	0	3 - 40	0
vii	0	2 - 7	0	3 - 7	0	3 - 41	0
viii	0	2 - 8	0	3 - 8	0	3 - 42	0
		2 - 9	0	3 - 9	0	3 - 43	0
1 - 1	0	2 - 10	0	3 - 10	0	3 - 44	0
1 - 2	0	2 - 11	0	3 - 11	0	3 - 45	0
1 - 3	0	2 - 12	0	3 - 12	0	3 - 46	0
1 - 4	0	2 - 13	0	3 - 13	0	3 - 47	0
1 - 5	0	2 - 14	0	3 - 14	0	3 - 48	0
1 - 6	0	2 - 15	0	3 - 15	0	3 - 49	0
1 - 7	0	2 - 16	blank	3 - 16	0	3 - 50	blank
1 - 8	0			3 - 17	0	3 - 51	0
1 - 9	0			3 - 18	0	3 - 52	0
1 - 10	0			3 - 19	0	3 - 53	0
1 - 11	0			3 - 20	0	3 - 54	0
1 - 12	0			3 - 21	0	3 - 55	0
				3 - 22	0	3 - 56	0
				3 - 23	0	3 - 57	0
				3 - 24	0	3 - 58	0
				3 - 25	0	3 - 59	0
				3 - 26	0	3 - 60	0
				3 - 27	0	3 - 61	0
				3 - 28	0	3 - 62	0
				3 - 29	0	3 - 63	0
				3 - 30	0	3 - 64	0
				3 - 31	0	3 - 65	0
				3 - 32	0	3 - 66	0
				3 - 33	0	3 - 67	0
				3 - 34	0	3 - 68	0



PAGE NUMBER	PAGE REV.	PAGE NUMBER	PAGE REV.	PAGE NUMBER	PAGE REV.	PAGE NUMBER	PAGE REV.
3 - 69	0	4 - 1	0	5 - 1	0	7 - 1	0
3 - 70	0	4 - 2	0	5 - 2	0	7 - 2	0
3 - 71	0	4 - 3	0	5 - 3	0	7 - 3	0
3 - 72	blank	4 - 4	0	5 - 4	0	7 - 4	blank
		4 - 5	0	5 - 5	0	7 - 5	0
		4 - 6	0	5 - 6	0	7 - 6	0
		4 - 7	0	5 - 7	0	7 - 7	0
		4 - 8	0	5 - 8	0	7 - 8	0
		4 - 9	0	5 - 9	0	7 - 9	0
		4 - 10	0	5 - 10	0	7 - 10	0
		4 - 11	0	5 - 11	0	7 - 11	0
		4 - 12	0	5 - 12	0	7 - 12	0
		4 - 13	0	5 - 13	0	7 - 13	0
		4 - 14	0	5 - 14	0	7 - 14	0
		4 - 15	0	5 - 15	0	7 - 15	0
		4 - 16	0	5 - 16	0	7 - 16	0
		4 - 17	0	5 - 17	0	7 - 17	0
		4 - 18	blank	5 - 18	0	7 - 18	0
		4 - 19	0	5 - 19	0	7 - 19	0
		4 - 20	blank	5 - 20	0	7 - 20	0
		4 - 21	0	5 - 21	0	7 - 21	0
		4 - 22	0	5 - 22	0	7 - 22	0
		4 - 23	0	5 - 23	0	7 - 23	0
		4 - 24	0	5 - 24	0	7 - 24	0
		4 - 25	0	5 - 25	0	7 - 25	0
		4 - 26	0	5 - 26	0	7 - 26	0
		4 - 27	0			7 - 27	0
		4 - 28	0	6 - 1	0	7 - 28	0
		4 - 29	0	6 - 2	0	7 - 29	0
		4 - 30	0	6 - 3	0	7 - 30	0
		4 - 31	0	6 - 4	0	7 - 31	0
		4 - 32	blank	6 - 5	0	7 - 32	0
				6 - 6	blank	7 - 33	0



PAGE NUMBER	PAGE REV.	PAGE NUMBER	PAGE REV.	PAGE NUMBER	PAGE REV.	PAGE NUMBER	PAGE REV.
7 - 34	0	8 - 1	0	9-A0-1	0		
7 - 35	0	8 - 2	0	9-A0-2	0		
7 - 36	0	8 - 3	0				
		8 - 4	0	9-A1-1	0		
		8 - 5	0	9-A1-2	0		
		8 - 6	0	9-A1-3	0		
		8 - 7	0	9-A1-4	0		
		8 - 8	0	9-A1-5	0		
		8 - 9	0	9-A1-6	0		
		8 - 10	0	9-A1-7	0		
		8 - 11	0	9-A1-8	0		
		8 - 12	0	9-A1-9	0		
		8 - 13	0	9-A1-10	0		
		8 - 14	0	9-A1-11	0		
		8 - 15	0	9-A1-12	0		
		8 - 16	0	9-A1-13	0		
				9-A1-14	0		
				9-A1-15	0		
				9-A1-16	0		
				9-A1-17	blank		
				back-cover	-		

SECTION

1



SECTION 1 – GENERAL

TABLE OF CONTENTS

PART	SUBJECT	PAGE NUMBER
1.1	INTRODUCTION	1-3
1.2	DESCRIPTION	1-3
1.3	CERTIFICATION BASIS	1-3
1.4	THREE VIEW DRAWINGS	1-4
1.5	DIMENSIONS AND WEIGHTS	1-5
	SYSTEMS	1-5
	Engine	
1.6	Propeller	
	Battery System	
	Landing Gear	
1.7	SYMBOLS, ABBREVIATIONS and TERMINOLOGY	1-7
1.8	CONVERSION TABLE	1-11
1.9	LIST OF APPLICABLE DOCUMENTS	1-12



1.1. INTRODUCTION

This section contains information of general interest to pilots and owners. You will find the information useful in acquainting yourself with the airplane, as well as in loading, sheltering, and handling the airplane during ground operations. Additionally, this section contains definitions or explanations of symbols, abbreviations, and terminology used throughout this handbook.

1.2. DESCRIPTION

The VELIS Electro is a two-seat aircraft of composite construction. The aircraft is arranged as a high wing mono-plane with cantilevered wings and a conventional empennage with a T-tail. It is equipped with a Pipistrel electric engine E-811-268MVLC and a fixed pitch propeller Pipistrel P-812-164-F3A.

The seats are side-by-side with full dual flight controls and shared levers for power output and flaperon control. Access to the cockpit is via two large gull-wing doors. There is no baggage compartment on the aircraft.

The load-bearing structure of the airplane is made of carbon, glass and aramid fiber composite material, the components of which, epoxy resin as well as fiber materials, are in compliance with worldwide accepted aviation specifications. The proven, low-pressure wet lay-up method from the sailplane industry is used to build the airplane structure.

The airplane is not approved for intentional spins and glider-towing.

1.3. CERTIFICATION BASIS

This aircraft is being certified under EASA CS-LSA Light Sport Aircraft Certification Specifications. Operation is restricted to VFR-day operations and a maximum take off weight of 600 kg.



1.4. THREE VIEW DRAWING



VELIS Electro
3-view drawing



1.5. DIMENSIONS AND WEIGHTS

Basic Dimensions	
Length	6.49 m
Span	10.71 m
Height	2.08 m
Wing	
Area	9.51 m ²
Span	10.71 m
Mean aerodynamic chord	0.898 m
Horizontal Tail	
Area	1.02 m ²
Span	2.18 m
Vertical Tail	
Reference area	0.86 m ²
Height	1.11 m
Weights	
Maximum take off weight	600 kg
Design empty weight	428 kg
Design useful load	172 kg
Maximum baggage weight	No baggage

1.6. SYSTEMS

1.6.1. ENGINE

The aircraft's Pipistrel E-811-268MVLC engine consists of an electric motor, the Pipistrel 268 MVLC VHML, and a dedicated H300C controller, which provides a maximum rated take off power of 65 kW.

The motor is a liquid cooled, axial flux synchronous permanent magnet electric motor.

The aircraft's power electronics system is a liquid-cooled, high-voltage power controller, which provides three phase alternating supply (AC) to the motor. Maximum continuous current is 300A.

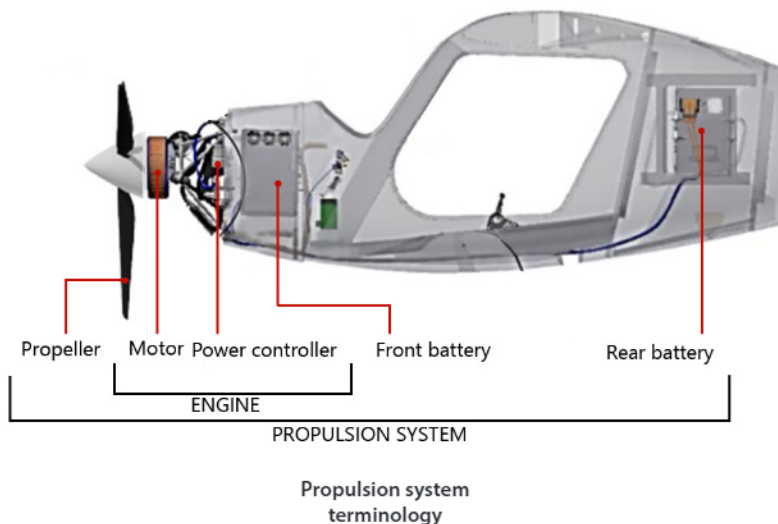

1.6.2. PROPELLER

VELIS Electro is equipped with a 3-blade fixed pitch, Pipistrel-designed P-812-164-F3A propeller. It has a diameter 1640 mm. Its blades are made from carbon fiber composite material and stainless steel. The blade root and propeller hub are machined aluminum parts.

1.6.3. BATTERY SYSTEM

The airplane features a high voltage electric power system. The primary energy source are two Pipistrel PB345V124E-L battery packs, which are located fore and aft of the cabin. This ensures redundancy of the power-source. In case of battery failure, the faulty battery gets automatically disconnected from the system. A single battery is capable of standalone operation and has enough power output capability to support aircraft climb and continuation of flight. The batteries are controlled by a BMS, that continuously monitors and manages battery parameters and status to ensure safe operations.

1.6.4. LANDING GEAR

The airplane has as a tricycle type fixed landing gear. The nose wheel is steerable via rudder pedals. The main wheels are equipped with hydraulic disc brakes, which are independently operated via toe-pedals. A parking brake lever is also present.



1.7. SYMBOLS, ABBREVIATIONS AND TERMINOLOGY

1.7.1. GENERAL AIRSPEED TERMINOLOGY AND SYMBOLS

- KCAS** Knots Calibrated Airspeed is the indicated airspeed corrected for position and instrument error expressed in knots. Calibrated airspeed (CAS) is equal to true airspeed in standard atmosphere at sea level.
- KIAS** Knots Indicated Airspeed is the speed shown on the airspeed indicator (IAS) expressed in knots. The IAS values published in this handbook assume no instrument error.
- KTAS** Knots True Airspeed is the airspeed expressed in knots relative to undisturbed air which is KCAS corrected for altitude and temperature.
- V_G** Best Glide Speed is the speed at which the greatest flight distance is attained per unit of altitude lost with power off.
- V_A** Operating Maneuvering Speed is the maximum speed at which application of full control movement will not overstress the airplane.
- V_{FE}** Maximum Flap Extended Speed is the highest speed permissible with wing flaps in a prescribed extended position.
- V_{NO}** Maximum Structural Cruising Speed is the speed that should not be exceeded except in smooth air, and then only with caution.
- V_{NE}** Never Exceed Speed is the speed that may not be exceeded at any time.
- V_{SO}** Stalling Speed is the minimum steady flight speed at which the aircraft is controllable in the landing configuration (100% flaps) at the most unfavorable weight and balance.
- V_X** Best Angle of Climb Speed is the speed at which the airplane will obtain the highest altitude in a given horizontal distance. The best angle-of-climb speed normally increases slightly with altitude.
- V_Y** Best Rate of Climb Speed is the speed at which the airplane will obtain the maximum increase in altitude per unit of time. The best rate-of-climb speed decreases slightly with altitude.
- V_H** Maximum speed in level flight with maximum continuous power.
- GS** Ground Speed is the horizontal speed relative to the ground.



1.7.2. METEOROLOGICAL TERMINOLOGY

- IMC** Instrument Meteorological Conditions are meteorological conditions expressed in terms of visibility, distance from cloud, and ceiling less than the minimal for visual flight defined in FAR 91.155.
- ISA** International Standard Atmosphere (standard day) is an atmosphere where
- (1) the air is a dry perfect gas,
 - (2) the temperature at sea level is 15 °C,
 - (3) the pressure at sea level is 1013.2 millibars (29.92 inHg), and
 - (4) the temperature gradient from sea level to the altitude at which the temperature is -56.5 °C is -0.00198 °C per foot and zero above that altitude.
- MSL** Mean Sea Level is the average height of the surface of the sea for all stages of tide. In this Handbook, altitude given as MSL is the altitude above the mean sea level. It is the altitude read from the altimeter when the altimeter's barometric adjustment has been set to the altimeter setting obtained from ground meteorological sources.
- OAT** Outside Air Temperature is the free air static temperature obtained from in-flight temperature indications or from ground meteorological sources. It is expressed in either degrees Celsius or degrees Fahrenheit.
- PA** Pressure Altitude is the altitude read from the altimeter when the altimeter's barometric adjustment has been set to 1013 mb (29.92 inHg) corrected for position and instrument error. In this Handbook, altimeter instrument errors are assumed to be zero.
- DA** Density Altitude (ft) is pressure altitude corrected for non-standard temperature. As temperature and altitude increase, air density decreases.
- Standard Temperature is the temperature that would be found at a given pressure altitude in the standard atmosphere. It is 15 °C at sea level pressure altitude and decreases approx. 2 °C for each 1000 feet of altitude increase.
- AAL** Above Aerodrome Level



1.7.3. PROPULSION SYSTEM TERMINOLOGY

BMS	Battery Management System
ENGINE	In this POH is defined as the system composed by electric motor and power controller.
HP	Horsepower is the power developed by the motor.
INTERLOCK	A system that detects power cable connection to the battery box. In case of disconnection, also interlock signal is lost and disconnection is detected.
kW	Kilowatt: it is unit that express the power developed by the motor.
MCP	Maximum Continuous Power is the maximum power that can be used continuously.
MPTOP	Minimum Performance Take off Power is the maximum power available for take off with batteries at the end of their service life and low SOC (SOH~0% and SOC=15%).
MTOP	Maximum Take Off Power is the maximum power available for take off, albeit for a limited time. This value can be reached when batteries are in good condition (high SOC/SOH).
PROPULSION SYSTEM	In this POH is defined as the system composed by electric motor, power controller, propeller and batteries.
RFT	Remaining Flight Time (displayed on EPSI, for information only)
RPM	Revolutions Per Minute is motor rotational speed.
SOC	State Of Charge (displayed on EPSI - Flight page) is the amount of energy stored in the battery, expressed as percentage of full capacity. Absolute full capacity is not constant, but can be affected by several factors (i.e. SOH, temperature).
SOH	State Of Health (displayed on EPSI - System page) indicates the "age" of the battery. End of life is SOH=0%. This parameter affects the absolute capacity of the battery (energy that can be stored), and the power that the battery can deliver.
TC	Power module of the charger.

1.7.4. PERFORMANCE TERMINOLOGY

- g One "g" is a quantity of acceleration equal to that of earth's gravity.
- Demonstrated Crosswind Velocity is the velocity of the crosswind component for which adequate control of the airplane during taxi, take off, and landing was actually demonstrated during certification testing.
- Service Ceiling is the maximum altitude at which the aircraft at maximum weight has the capability of climbing at a 100 ft/min.



1.7.5. WEIGHT AND BALANCE TERMINOLOGY

- MTOM** **Maximum Take Off Mass** is the maximum overall mass allowed at take off.
- C.G. or CG** **Center of Gravity** is the point at which an airplane would balance if suspended. Its distance from the reference datum is found by dividing the total moment by the total weight of the airplane. All references to C.G. in this manual are references to the in-flight C.G.
- **Arm** is the horizontal distance from the reference datum to the center of an item's gravity. The airplane's arm is obtained by adding the airplane's individual moments and dividing the sum by the total weight.
 - **Basic Empty Weight** is the actual weight of the airplane including all operating fix installed equipment of the airplane.
- MAC** **Mean Aerodynamic Chord** is the chord drawn through the centroid of the wing plan area.
- R or LEMAC** **Leading Edge of Mean Aerodynamic Chord** is the forward edge of MAC aft of the reference datum.
- **Maximum Gross Weight** is the maximum permissible weight of the airplane and its contents as listed in the aircraft specifications.
 - **Moment** is the product of the item weight multiplied by its arm.
 - **Useful Load** is the basic empty weight subtracted from the maximum weight of the aircraft. It is the maximum allowable combined weight of pilot and passenger.
 - **Reference Datum** is an imaginary vertical plane from which all horizontal distances are measured for balance purposes.
 - **Tare** is the weight of all items used to hold the airplane on the scales for weighing. Tare includes blocks, shims, and chocks. Tare weight must be subtracted from the associated scale reading.
- WBR** **Weight and Balance Report** is part of the aircraft documentation and is a record of aircraft empty weight and C.G. location.
- MLE** **Minimum List of Equipment** is the list of instruments, systems and equipment that must be on board and functional for a kind of operation.
- TOM** **Take Off Mass** is the aircraft mass at take off. On VELIS Electro this value does not change during the entire flight.



1.7.6. ADDITIONAL ABBREVIATIONS

AH	Artificial Horizon
AHRS	Attitude and Heading Reference System
AOA	Angle Of Attack
BATT	Battery/Batteries
COM	Communication - Radio
EA	Electrical Aircraft
ELT	Emergency Locator Transmitter
HV	High Voltage
IFR	Instrumental Flight Rules
NVFR	Night-Visual Flight Rules
PVS	Pipistrel Vertical Solutions
VFR	Visual Flight Rules

1.8 CONVERSION TABLE

SI	US	US	SI
1 bar	14.5037 psi	1 psi	0.0689 bar
1 mm ²	0.0016 in ²	1 in ²	625 mm ²
1 cm ²	0.1550 in ²	1 in ²	6.4510 cm ²
1 daN	2.2481 lbf	1 lbf	0.4448 daN
1 g	0.0353 oz	1 oz	28.328 g
1 hPa	0.0295 inHg	1 inHg	33.898 hPa
1 kg	2.2046 lb	1 lb	0.4536 kg/min
1 kg/min	2.2046 lb/min	1 lb.min	0.4536 kg/min
1 l	0.2641 US gal	1 US gal	3.7864 l/min
1 l	1.057 US quart	1 US quart	0.9461 l
1 l/min	0.2641 US gal/min	1 US gal.min	3.7864 l/min
1 daNm	88.4956 lbf.in	1 lbf.in	0.0113 daNm
1 daNm	7.3801 lbf.ft	1 lbf.ft	0.1355 daNm
1 m	3.2809 ft	1 ft	0.3040 m
1 mm	0.0394 in	1 in	16.393 mm
1 cm ³	0.06102 in ³	1 in ³	16.393 cm ³
1 hPa	0.0145 psi	1 psi	68.965 hPa



1.9 LIST OF APPLICABLE DOCUMENTS

Reference	Document
[1]	WBR-128-08-10-XXX* Weight and Balance Report
[2]	ELT_345_Manual_Y1-03-0282J
[3]	EIM-811-00-60-7202 Engine Operator`s Manual
[4]	PIM-812-61-00-001 Propeller Instruction Manual
[5]	AMM-128-00-60-001 Aircraft maintenance manual
[6]	Horis - Installation and User Manual (by Kanardia d.o.o.)
[7]	SB-128-00-80-001 Flight_Data_Logging
[8]	SPOH-128-00-40-001 Leaflet ground risks

* Where XXX represents the aircraft's serial number

NOTE: Latest revision of listed documents has to be used.

SECTION

2



SECTION 2 – LIMITATIONS

TABLE OF CONTENTS

PART	SUBJECT	PAGE NUMBER
2.1	INTRODUCTION	2-3
2.2	AIRSPEED LIMITATION	2-3
2.3	AIRSPEED INDICATOR MARKINGS	2-4
2.4	ENGINE AND PROPELLER LIMITATIONS	2-4
2.5	ENGINE INSTRUMENT MARKINGS	2-5
2.6	WEIGHT AND CENTER OF GRAVITY LIMITS	2-5
2.7	OCCUPANCY	2-5
2.8	COOLANT	2-6
2.9	FLIGHT LOAD FACTOR LIMITS	2-6
2.10	MANEUVER LIMITS	2-6
2.11	ALTITUDE LIMITS	2-7
2.12	TEMPERATURE LIMITS	2-7
2.13	MINIMUM FLIGHT CREW	2-7
2.14	KINDS OF OPERATIONS	2-7
2.15	OPERATIONAL RESTRICTIONS	2-9
2.16	PLACARDS	2-10
	Placards (External)	
	Placards (Engine and batt compartments)	
	Placards (Instrument Panel)	
	Placards (Center Console)	
	Placards (Cabin)	
	Placards (External - High Voltage Hazard)	

APPROVED

PAGE
2-2

PIPISTREL

POH-128-00-40-001
PAGE REV. 0



2.1 INTRODUCTION

This section provides operating limitations, instrument markings and basic placards necessary for the safe operation of the airplane and its standard systems and equipment.

2.2 AIRSPEED LIMITATIONS

All speeds in the table below are KIAS.

Speed	KIAS	Remarks
V_{NE}	108	Never Exceed Speed is the speed limit that may not be exceeded at any time. Maximum speed for all operations.
V_{NO}	98	Maximum Structural Cruising Speed is the speed that should not be exceeded except in smooth air.
V_A	100	Operating Maneuvering Speed is the maximum speed at which full control travel may be used.
V_{FE}	81	Maximum Flap Extended Speed is the highest speed permissible with wing flaps extended at (+1) stage, 65 KIAS for (+2) stage.
V_{SO}	46	Stall speed in landing configuration. Stall speed for flaps (+2) stage.
V_S	53	Stall speed clean. Stall speed for flaps (0) stage.



2.3 AIRSPEED INDICATOR MARKINGS

All speeds in the table below are KIAS.

MARKING	VALUE	REMARKS
White Arc	46 - 81	Flap Operating Range. Lower limit is the most adverse stall speed in the landing configuration. Upper limit is the maximum speed permissible with flaps extended at 1 st stage.
White triangle	65, 81	Flap speed limitations for (+2) stage, (+1) stage.
Green Arc	53 - 98	Normal Operating Range. Lower limit is the maximum weight stall at most forward C.G. in clean configuration. Upper limit is the maximum structural cruising speed. NOTE: Clean configuration is regarded as Flaps in position (0).
Yellow Arc	98 - 108	Caution Range. Operations must be conducted with caution and only in smooth air.
Red Line	108	Never exceed speed. Maximum speed for all operations.

2.4 ENGINE AND PROPELLER LIMITATIONS

ENGINE	Pipistrel electric engine E-811-268MVLC
Maximum rated take off power (MTOp)	57.6 kW (limited to 90 sec)
Maximum rated continuous power (MCP)	49.2 kW
Maximum take off rpm	2500 RPM (electronically limited)
Maximum continuous rpm	2350 RPM
Motor temperature	min -20 °C, max +110 °C
Power controller temperature	min -20 °C, max +70 °C
PROPELLER	Pipistrel propeller P-812-164-F3A
Maximum rpm	2500 RPM
Maximum continuous rpm	2300 RPM

APPROVED

PAGE
2-4

PIPISTREL

POH-128-00-40-001
PAGE REV. 0



2.5 ENGINE INSTRUMENT MARKINGS (EPSI570C)

EPSI570C	RED LINE	GREEN ARC	YELLOW ARC	RED LINE
	MINIMUM	NORMAL	CAUTION	MAXIMUM
Tachometer (RPM)		0 / 2299	2300 / 2499	2500
Motor temp. (°C)		(-20) / 99	100 / 109	110
Power controller temp. (°C)		(-20) / 64	65 / 69	70
Battery sys temp. (°C)	5	11 / 50	6 / 10 51 / 57	58
Motor Power (PWR) (kW)*		0 / 48	49 / 65	66

* **NOTE:** Additional markings for motor power indication on EPSI570C are: a) Single battery operation power setting - 40 kW - b) Minimum Performance Take Off Power - MPTOP - 50 kW (low battery SOH).

2.6 WEIGHT AND CENTER OF GRAVITY LIMITS

Maximum take off weight	600 kg
Maximum useful load	172 kg
Maximum landing weight	600 kg
Most forward CG (with crew)	25.2 % MAC / 269 mm
Most rearward CG (with crew)	32.6 % MAC / 336 mm

NOTE: The reference datum is wing's leading edge at root.

2.7 OCCUPANCY

Max. Occupancy	Pilot and 1 Passenger
Minimum weight solo pilot	34 kg
Maximum weight per seat	110 kg
Maximum pilot and occupant weight	172 kg
Maximum baggage weight	No baggage



2.8 COOLANT

Motor, power electronics and batteries are liquid cooled (distilled water/glycol).

Approved coolant	50% water + 50% glycol automotive grade G12+
Min/max coolant quantity	Marked on expansion tanks, visible through check windows
Cooling system capacity	0.9 L for engine system 5.4 L for battery system

2.9 FLIGHT LOAD FACTOR LIMITS

Up to V_A	+ 4.0 g / - 2.0 g
Up to V_{NE}	+ 4.0 g / - 2.0 g

2.10 MANEUVER LIMITS

Aircraft is intended for “non-aerobatic” and for “VFR day” operation only. Non-aerobatic operation includes:

- a) Any maneuver incidental to normal flying
- b) Stalls (except whip stalls)
- c) Eights, chandelles, and steep turns, in which the angle of bank is not more than 60°.

All spins are prohibited.



2.11 ALTITUDE LIMITS

Maximum operating altitude	12,000 ft MSL
----------------------------	---------------

2.12 TEMPERATURE LIMITS

Do not fly when the temperature of the aircraft's surface is at risk of exceeding 55 °C.

Aircraft can be operated between $-20\text{ °C} < \text{OAT} < +35\text{ °C}$

Batteries should be stored between $0\text{ °C} < \text{OAT} < +30\text{ °C}$
(recommended %SOC range 30-80 %SOC)

Minimum battery temperature before engine start is 0 °C
(Protected by automatic self test at start up)

Maximum battery temperature at take off is +45 °C *

Charging temperature range is $0\text{ °C} < \text{battery temperature} < +45\text{ °C}$

***CAUTION:** when battery temperatures are above 40 °C, prolonged high-power application (circuit patterns or prolonged climb at MCP) may lead to battery high temperature.

2.13 MINIMUM FLIGHT CREW

The minimum flight crew is one pilot.

2.14 KIND OF OPERATIONS

The airplane is approved for VFR-Day operations only.

NOTE: The airplane must be equipped according to the MLE for the planned kind of operation, see 2.14.1.



2.14.1 MINIMUM LIST OF EQUIPMENT

SYSTEM, INSTRUMENT, EQUIPMENT	MLE - REQUIRED FOR KIND OF OPERATION (item Qty)
	VFR Day
VHF COM / (NAV)	—
Transponder	—
Low Voltage Battery (aux battery)	1
Ammeter / Indication	1*
Emergency Locator Trans.	—
Pitch Trim Indicator	1
Pitch Trim Actuator	1
Airplane Flight Manual	1
Airspeed Indicator	1
Altimeter	1
Magnetic Compass	1
Pitot System	1
Static System	1
Kanardia Horis	—
Vertical Speed Indicator	—
EPSI570C	1
High Voltage Battery	2
Warning Panel/Annunciator	1
Batt Overtemp Warning Lights	2
Motor Power Indicator	1*
Battery SOC/SOH indicators	2*
RPM Indicator	1*
RPM/Power Indicator Backup (Kanardia)	—
Motor Temperature Indicator	1*
Power Controller Temperature Indicator	1*
Battery Temperature Indicators	2*
Stall Warning System	1

* The indication is integrated into the EPSI570C system/display.



2.15 OPERATIONAL RESTRICTIONS

Flight under Instrument Flight Rules (IFR) is not permitted.

NVFR Flight is not permitted.

Minimum SOC at take off = 50%.

Standard mission planning must consider 30% SOC as minimum value at landing.

Do not initiate a go-around procedure if SOC < 15%.
(Remaining energy will not be sufficient for another safe circuit pattern)

MTOP must be limited to 90 seconds.

Flight into known icing conditions is prohibited.

No flights in heavy rainfall or blizzard conditions.

Areas with risk of thunderstorms should be avoided.

Smoking is prohibited.

Do not fly when the temperature of the aircraft's surface is at risk of exceeding 55 °C.

Aircraft can be operated only when $-20\text{ °C} < \text{OAT} < +35\text{ °C}$.

Maximum battery temperature at take off is $+45\text{ °C}^*$

Avoid applying more than 75% rudder deflection during cruise/climb/approach as this may cause a pitch-down moment.

The USB power outlets are not approved to supply power to flight-critical communication or navigation devices.

No intentional spins.

AHRS (Kanardia Horis) and GPS is for information only and should not be used for primary navigation as well as attitude and heading references.

***CAUTION:** when battery temperatures are above 40 °C, prolonged high-power application (circuit patterns or prolonged climb at MCP) may lead to battery high temperature.



2.16 PLACARDS

2.16.1 PLACARDS (EXTERNAL)



Next to nose wheel



Next to main wheels (2x)



Next to door handles



On charging port door
on the upper engine cowling



On the inner side
of charging port door

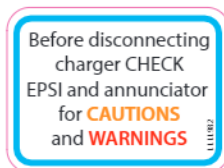

Over the battery exhaust
outlets (2x)



Next to battery cooling inlet/outlet
on the fuselage



Next to engine and battery cooling system coolant
overflow hoses



Around the static ports (2x)



Around the drainage holes in
fuselage, wings, control surfaces
(16x)

2.16.2 PLACARDS (ENGINE AND BATT COMPARTMENTS)

On battery packs:



(6x each
battery pack)



(6x each
battery pack)



(1x each
battery pack)



50 % ANTIFREEZE
+ 50 % WATER
1111122

On coolant expansion tanks (2x)

2.16.3 PLACARDS (INSTRUMENT PANEL)

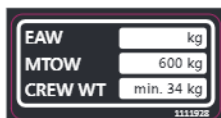

APPROVED TO FLY IN VISUAL METEOROLOGICAL CONDITIONS (VMC) ONLY!
FLIGHTS IN INSTRUMENTAL METEOROLOGICAL CONDITIONS (IMC) ARE PROHIBITED!
1111723

MIN 50% SOC
AT TAKE-OFF
1111983

MAX 40 kW
WITH ONE BATTERY INOPERATIVE
1111929

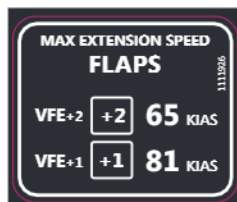
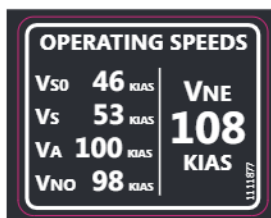

Next to microphone/
headphone jacks

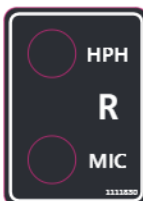
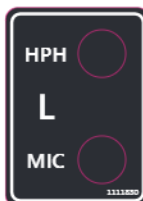

APPROVED

PAGE
2-12

PIPISTREL

POH-128-00-40-001
PAGE REV. 0



On the left and right side of the instrument panel

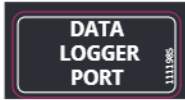

2.16.4 PLACARDS (CENTER CONSOLE)

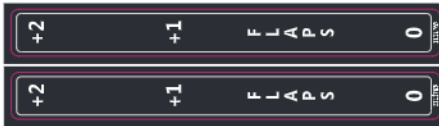

Next to flap lever



Next to parking brake lever



Next to power lever



2.16.5 PLACARDS (CABIN)



In front of control sticks
rudder pedal adjustment (2x)

Below each door to depict door handle operation



On the cabin support strut in front of the pilot



Next to the compass

DATE:	Calibrated with radio ON OFF					
For	N	30	60	E	120	150
Steer						
For	S	210	240	W	300	330
Steer						



2.16.6 PLACARDS (EXTERNAL - HIGH VOLTAGE HAZARD)

On battery compartment access panels (3x)



On the aircraft belly (3x)





This page is intentionally left blank.

SECTION

3



SECTION 3 – EMERGENCY PROCEDURES

TABLE OF CONTENTS

PART	SUBJECT	PAGE NUMBER
3.1	INTRODUCTION	3-5
3.2	WARNING / CAUTION INDICATION SYSTEM EPSI570C Warning and Caution Messages	3-6
3.3	AIRSPEDS FOR EMERGENCY OPERATIONS	3-11
3.4	GROUND EMERGENCIES Engine Fire on Ground Battery Fire on Ground Emergency Motor Shutdown on Ground Emergency Ground Egress Battery Failure at System Start-Up Battery Coolant Fan Failure Only One Battery Connected DC/DC Converter Failures Propulsion System Component Failures Power Lever / Engine Communication Failure	3-11
3.5	IN-FLIGHT EMERGENCIES Complete Power Loss after Take off Complete Power Loss in Flight Motor restart in Flight Partial Power Loss Battery Disconnected Battery High Temperature Battery Overtemperature Battery Not Present Engine High Temperature Engine Overtemperature Battery Overcurrent Low State of Charge (Low SOC)	3-18



PART	SUBJECT	PAGE NUMBER
3.5	No Go-around Available	
	Battery SOC Adjusted	
	Battery Cell Low Voltage	
	Battery Coolant Pump Failure	
	Engine Communication Failure	
	Engine Coolant Pump Failure	
	Electrical System Insulation Failure	
	DC/DC Converter Failures (in Flight)	
	Power Lever Communication Failure	
	Battery Current Not Equal	
3.6	FIRE IN FLIGHT	3-39
	Engine Fire in Flight	
	Battery System Fire	
	Cockpit Fire in Flight	
3.7	SPINS	3-41
3.8	EXCEEDING V_{NE}	3-41
3.9	LANDING EMERGENCIES	3-42
	Emergency Landing	
	Ditching	
	Landing with a Defective Main Landing Gear Tire	
	Landing with Defective Brakes	
3.10	EPSI570C DISPLAY FAILURE	3-45
3.11	RADIO COMMUNICATION FAILURE	3-46
3.12	PITOT STATIC SYSTEM MALFUNCTION	3-46
3.13	ELECTRIC TRIM FAILURE	3-47
3.14	AUXILIARY BATTERY FAILURE	3-47
3.15	ICE BUILD-UP	3-48
3.16	EMERGENCY PROCEDURES - CHECK-LIST	3-49



This page is intentionally left blank.



3.1 INTRODUCTION

This section provides procedures for handling emergencies and critical flight situations. Although emergencies caused by airplane, systems, or engine malfunctions are extremely rare, the guidelines described in this section should be considered and applied as necessary should an emergency arise.

En-route emergencies caused by weather can be minimized or eliminated by careful flight planning and good judgment when unexpected weather is encountered.

In-flight mechanical problems will be extremely rare if proper preflight inspections and maintenance are practiced. Always perform a thorough walk-around preflight inspection before any flight to ensure that no damage occurred during the previous flight or while the airplane was on the ground.

Aircraft emergencies are very dynamic events. Because of this, it is impossible to address every action a pilot might take to handle a situation. However, four basic actions can be applied to any emergency:

Maintain Aircraft Control

Many minor aircraft emergencies turn into major ones when the pilot fails to maintain aircraft control. Remember, do not panic and do not fixate on a particular problem. To avoid this, even in an emergency: aviate, navigate, and communicate, in this order. Never let anything interfere with your control of the airplane. Never stop flying.

Analyze the Situation

Once you are able to maintain control of the aircraft, assess the situation. Look at the propulsion system parameters. Determine what the airplane is telling you.

Take Appropriate Action

In most situations, the procedures listed in this section will either correct the aircraft problem or allow safe recovery of the aircraft. Follow them and use good pilot judgment.



Land immediately

Continuation of the flight may be more hazardous than ditching or landing in terrain normally considered unsuitable.

Land as soon as possible

Find the nearest suitable area, such as an open field, at which a safe approach and landing is assured, and land without delay.

Land as soon as practical

The continuation of the flight and the landing site, such as the nearest available runway, is at the discretion of the pilot. It is not recommended to continue the flight beyond the nearest suitable landing area.

3.2 WARNING/CAUTION INDICATION SYSTEM

The aircraft is equipped with two main independent failure indication systems. The first is composed of the EPSI570C display and annunciator panel, which are software governed. This system informs the pilot about propulsion system component malfunctions and failures by means of warning/caution messages and aural warnings.

The second system is specifically designed to warn the pilot about battery overtemperature. It is analog and consists of battery temperature sensors and two warning LED lights, one for each battery pack, installed on the instrument panel. The overtemperature warning lights are activated when the analog sensors detect a battery temperature above 58 °C (warning range).



**Example: front (F) battery
overtemp warning light active**



The 58 °C threshold coincides also with the temperature at which automatic disconnection of the battery is triggered by the digital system. This is accompanied by a warning message on EPSI570C and annunciator.

The digital and the analog systems are both operative at the same time (normal condition) and, in the event of battery overtemperature, the warning is signaled by both. In the case of EPSI570C display/software malfunction, the analog system remains operative.

NOTE: Battery overtemperature requires emergency procedures described in section Battery Overtemperature (3.5.7).

See section (3.2.1) for the list of warning and caution messages and appendix 9-A1 and section (7.6.5) for more information about the use of the EPSI570C, annunciator panel and battery overtemperature warning lights.

WARNING: Do not take off if any warning or caution appears on the EPSI570C display, annunciator panel or battery overtemperature warning lights.

Additionally, a third warning system is installed. It is a aural and haptic stall warning system in the control stick handles that are activated when the angle of attack becomes critical.



3.2.1 EPSI570C WARNING AND CAUTION MESSAGES

The following table presents the possible warning and caution messages that appear on the EPSI570C display.

WARNING: Do not take off if any warning or caution appears on the EPSI570C display, annunciator panel or battery overtemperature warning lights.

WARNINGS		
BATTERY WARNINGS		
Warning Message	Description	Section
BATTERY F/R DISCONNECTED DUE TO: OVERVOLTAGE / UNDERVOLTAGE / INTERLOCK ERROR / INTERNAL HW FAILURE	This message indicates that the system has automatically disconnected a battery pack due to one of the reasons listed.	3.4.9 3.5.5
BATTERY F/R DISCONNECTED DUE TO: OVERTEMPERATURE	This message indicates an automatic battery disconnection due to overtemperature.	3.5.7
ENGINE WARNINGS		
Warning Message	Description	Section
ENGINE OVERTEMPERATURE	Power controller temperature or motor temperature in warning range. Power controller derating is active.	3.5.10

CAUTIONS		
BATTERY CAUTIONS		
Caution Message	Description	Section
BATTERY F/R HIGH TEMPERATURE	The system has detected a battery temperature in the caution range.	3.4.9 3.5.6
BATTERY F/R ABOUT TO DISCONNECT	Battery temperature is rising into the warning range and system will disconnect the battery soon.	3.4.9 3.5.6

APPROVED

PAGE
3-8

PIPISTREL

POH-128-00-40-001
PAGE REV. 0



BATTERY F/R NOT PRESENT	The system is unable to communicate with the battery. (via CAN-bus communication system)	3.4.7 3.4.9 3.5.5 3.5.8
ONLY ONE BATTERY PACK IS ACTIVE	This caution appears when the power controller is ON and when motor RPM >300. Only one battery can delivery power. This message is meant to avoid the possibility of taking off with only one pack active and providing power.	3.4.7 3.4.9 3.5.5
BATTERY F/R OVERCURRENT	The system has detected an overcurrent from the battery.	3.4.9 3.5.11
BATTERY VOLTAGES NOT EQUAL	Difference between battery voltages is >5V.	3.4.5
SOC <30%	State of charge is less than 30%.	3.4.9 3.5.12
NO GO-AROUND AVAILABLE	Appears when SOC<15%. Batteries are almost discharged. Only few minutes of power left.	3.5.13
BATTERY F/R STARTUP FAILED	This message appears after turning the power enable switch on during ground operation.	3.4.5
BATTERY F/R SOC ADJUSTED	This message informs the pilot that SOC has been recalculated and updated.	3.5.14
BATTERY F/R LOW CELL VOLTAGE	The system has detected a low voltage in the battery cells.	3.5.15
BATTERY COOLANT PUMP 1/2 FAILURE	Battery coolant pump 1 or 2 malfunction.	3.5.16
BATTERY COOLANT FAN FAILURE	Battery coolant fan malfunction. This caution appears during recharging.	3.4.6
BATTERY F/R SELFTEST FAILED PBIT	The system has detected battery parameter anomalies during system startup.	3.4.5
BATTERY F/R SELFTEST FAILED LOW TEMP	The system has detected battery temperatures below the limit for startup (<0°C)	3.4.5



ENGINE CAUTIONS		
Caution Message	Description	Section
ENGINE HIGH TEMPERATURE	Power controller temperature or motor temperature in caution range. If temperatures keep increasing expect "Engine Overtemperature" warning message.	3.4.9 3.5.9
ENGINE COMMUNICATION FAILURE	Power setting can't be changed and remains at the last valid setting.	3.4.10 3.5.17
ENGINE COOLANT PUMP FAILURE	Engine coolant pump malfunction. Expect rise of power controller and motor temperatures, power derating and power cut off.	3.4.9 3.5.18
SYSTEM CAUTIONS		
Caution Message	Description - Action	
SYSTEM ISOLATION FAILURE	The system has detected a failure in the electrical insulation between high voltage and low voltage systems/lines.	3.5.19
DC/DC COMMUNICATION FAILURE	DC/DC system malfunction. Auxiliary battery might not be recharged.	3.4.8 3.5.20
DC/DC NOT WORKING	DC/DC system malfunction. Auxiliary battery might not be recharged.	3.4.8 3.5.20
POWER LEVER COMMUNICATION FAILURE	Power lever malfunction. Power setting can't be changed and remains at the last valid setting.	3.4.10 3.5.21
BATTERY CURRENT NOT EQUAL	Max permissible difference in electrical current between batteries is out of tolerance. This message also appears when one battery is disconnected (current is 0).	3.5.22
AUXILIARY BATTERY FAILURE	Auxiliary battery malfunction. No backup available in case of DC/DC converter failure.	3.14



3.3 AIRSPEEDS FOR EMERGENCY OPERATIONS

Maneuvering Speed:	100 KIAS
Best Glide Speed (flaps 0):	70 KIAS

Emergency Landing (Engine-out) - Final approach speeds:

Flaps 0	63 KIAS
Flaps +1	60 KIAS
Flaps +2	58 KIAS

3.4 GROUND EMERGENCIES

3.4.1 ENGINE SYSTEM FIRE ON GROUND

Should you encounter firewall-forward fire on the ground, react as follows:

1	Come to a complete standstill	-
2	MASTER switch	OFF
3	BATT EN switch	OFF
4	PWR EN switch	OFF
5	BATT REAR & BATT FRONT circuit breakers	DISENGAGE
6	PWR CTRL circuit breaker	DISENGAGE
7	Emergency ground egress procedure (3.4.4)	PERFORM

WARNING: A waterless agent fire extinguisher should be used in case of engine system fire.

WARNING: DO NOT attempt to restart the motor after an engine system fire.

3.4.2 BATTERY FIRE ON GROUND

A clear indication of battery fire is dense smoke and a distinctive chemical smell. Fire can develop quickly and aggressively. Should you encounter battery fire on the ground, react as follows:



1	Come to a complete standstill	-
2	MASTER switch	OFF
3	BATT EN switch	OFF
4	BATT REAR & BATT FRONT circuit breakers	DISENGAGE
5	Emergency ground egress procedure (3.4.4)	PERFORM

WARNING: Be aware that lithium battery fires are extremely dangerous because they are self-sustaining! They are a result of a chemical reactions and are impossible to extinguish. You can only prevent or delay fire propagation by continually cooling down the batteries and surrounding items with copious amount of water.

NOTE: expect battery overtemperature analog warning lights ON in case of battery fire/overtemperature.

WARNING: DO NOT attempt to restart the motor or to reconnect the batteries after a battery system fire. Aircraft should be under surveillance for at least 24h due to possible latent battery thermal runaway or late cell ignition.

3.4.3 EMERGENCY ENGINE SHUTDOWN ON GROUND

1	Power Lever	CUT OFF
2	MASTER Switch	OFF
3	BATT EN Switch	OFF
4	PWR EN Switch	OFF
5	PWR CTRL Circuit breaker	DISENGAGE

3.4.4 EMERGENCY GROUND EGRESS

1	Engine	SHUTDOWN
2	Parking brake	ENGAGE
3	Seat belts	RELEASE
4	Airplane	EXIT
5	Vicinity of airplane	EVACUATE

APPROVED



While exiting the airplane, make sure the evacuation path is clear of other aircraft, spinning propellers and/or other hazards.

3.4.5 BATTERY FAILURE AT SYSTEM START-UP

The system performs a self test on electrical components during the start-up phase. Batteries are included in the checks.

In case of battery malfunction during system test (or temperatures below 0°C) the following caution messages can appear:

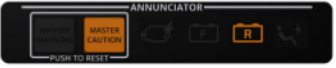
EPSI570C message	Annunciator
<p>BATTERY F/R SELFTEST PBIT/LOW TEMP FAILED <i>(amber)</i></p>	<p>ANNUNCIATOR</p>  <p>or</p> 
<p>BATTERY F/R STARTUP FAILED <i>(amber)</i></p>	<p>ANNUNCIATOR</p>  <p>or</p> 

CAUTION: If these messages appear, do not continue start up. If reason is low battery temperature, try to start up when battery temperature is >0°C. If failure persists, or in case of other messages contact CAMO/CAO.

EPSI570C message	Annunciator
<p>BATTERY VOLTAGES NOT EQUAL <i>(amber)</i></p>	<p>ANNUNCIATOR</p> 

1 DO NOT TAKE OFF

CAUTION: If this message appears, do not take off. Try to fully recharge batteries. If the message persists, contact CAMO/CAO.



3.4.6 BATTERY COOLANT FAN FAILURE

The battery coolant fan is used during the recharging phase. If the battery coolant fan fails, charging power is derated to 0 kW (see also Section 8 for additional information about charging procedure) and the following caution message appears:

EPSI570C message	Annunciator
BATTERY COOLANT FAN FAILURE (amber)	

1 Recharging procedure

ABORT

NOTE: Contact CAMO/CAO.

3.4.7 ONLY ONE BATTERY CONNECTED

If a battery is not detected in the CAN-bus communication line (also consequent to battery circuit breaker disengagement) there is no communication between the system controller and the battery. When this occurs the following message appears:

EPSI570C message	Annunciator
BATTERY F/R NOT PRESENT (amber)	 or 

1 DO NOT TAKE OFF

-

Additionally, on EPSI570C the parameters of the battery that is not communicating are not available and are covered by a red cross (See section 9-A1 for details).

If communication with the battery is still possible, but the disconnection hap-



pens at the power line interface of the battery, the following message appears on the EPSI570C as soon as RPM reaches 300 RPM, to avoid take off with a single battery delivering power.

EPSI570C message	Annunciator
<p>ONLY ONE BATTERY PACK IS ACTIVE (amber) (if RPM>300)</p>	

1 DO NOT TAKE OFF	-
--------------------------	---

CAUTION: If these messages appear, do not take off. Check battery connectors. If the problem is not solved, contact CAMO/CAO. If they appear in flight see [Single battery disconnection emergency procedures \(3.5.5\)](#).

3.4.8 DC/DC CONVERTER FAILURES

When the system detects a DC/DC converter failure, the auxiliary battery is not being recharged. This means the engine, several instruments and systems, required according to the MLE, will soon become inoperative. Expect one of the following caution messages to appear:

EPSI570C message	Annunciator
<p>DC/DC COMMUNICATION FAILURE (amber)</p>	
<p>DC/DC NOT WORKING (amber) (if RPM>300)</p>	

1 DO NOT TAKE OFF	-
--------------------------	---

CAUTION: If these messages appear, do not take off and contact CAMO/CAO.



3.4.9 PROPULSION SYSTEM COMPONENT FAILURES

CAUTION: If any warning or caution messages related to propulsion system components appear while on the ground (engine or battery high temperature, engine overtemperature, battery overcurrent, coolant pumps, battery disconnection etc), do not take off.

If any warning or caution message appears while on the ground:

- If take off run is not initiated yet:

1	DO NOT TAKE OFF	-
----------	-----------------	---

CAUTION: Contact CAMO/CAO.

- If the take off run is initiated and conditions (speed, available runway) permit safe aircraft stoppage:

1	Come to a complete standstill	PERFORM
2	MASTER switch	OFF

NOTE: If the warning/caution message is battery related, disengage affected battery circuit breaker. Expect additional caution messages caused by battery disconnection/single battery operation to appear.

3	MASTER switch	ON
4	Taxi off the runway (using low power setting)	PERFORM
5	Shutdown procedure (4.12)	PERFORM

- If conditions do not permit safe aircraft stoppage:

3	Take off	CONTINUE
4	Land	AS SOON AS PRACTICAL



CAUTION: Contact CAMO/CAO.

3.4.10 POWER LEVER / ENGINE COMMUNICATION FAILURE

If a power lever or engine communication failure occurs, the power setting can't be adjusted by the pilot and remains at the last valid value before the communication loss. Expect one of the following caution messages to appear:

APPROVED



EPSI570C message	Annunciator
POWER LEVER COMMUNICATION FAILURE (amber)	
EPSI570C message	Annunciator
ENGINE COMMUNICATION FAILURE (amber)	

- If the take off run is not initiated yet:

1	PWR CTRL circuit breaker	DISENGAGE
2	Power lever	CUT OFF
3	Shutdown procedure (4.12)	PERFORM
4	Parking procedure (4.13)	PERFORM

- If take off run is initiated and there is enough runway to stop the aircraft or power/speed is not sufficient for lift off and climb:

1	PWR CTRL circuit breaker	DISENGAGE
2	Power lever	CUT OFF
3	Come to a complete standstill	PERFORM
4	Shutdown procedure	PERFORM
5	Push the aircraft off the runway	PERFORM
6	Parking procedure (4.13)	PERFORM

- If there is not enough runway available to stop, and power/speed is sufficient for lift off and climb: perform Engine / power lever communication failure (in flight) procedures (3.5.17 / 3.5.21).

NOTE: In the case of an engine communication failure, all parameters related to motor and power controller, including the parameters (RPM, kW) displayed on Kanardia instrument installed in front of the left seat, are covered with a red cross. The values displayed represent the last valid output.

CAUTION: Contact CAMO/CAO.



3.5 IN-FLIGHT EMERGENCIES

3.5.1 COMPLETE POWER LOSS AFTER TAKE OFF

If complete power loss occurs immediately after becoming airborne and a runway landing is possible, abort with a runway landing. If, however, altitude attained precludes a runway stop, but is not sufficient to restart the motor, lower the nose to maintain airspeed and establish a glide attitude. In most cases, the landing should be made straight ahead, turning only to avoid obstructions. After establishing a glide for landing, perform as many of the checklist items as time permits.

1	Best Glide or Landing Speed (as appropriate)	ESTABLISH
2	BATT FRONT & BATT REAR Circuit breakers	DISENGAGE
3	PWR CTRL Circuit breaker	DISENGAGE
4	Flaps	AS REQUIRED
5	Land (emergency landing)	PREPARE TO LAND

WARNING: Do not change course or make turns if this is not of vital necessity! After having landed safely, ensure protection of the aircraft and vacate the runway to keep the runway clear for arriving and departing traffic. Do this calmly and carefully, so as to avoid injury and equipment damage.

WARNING: If a turn back to the runway is elected, be very careful not to stall the airplane.

Minimum recommended altitude for attempting a turn back to the runway:

Power loss in upwind leg	at least 700 ft AAL
Power loss in crosswind leg	at least 500 ft AAL

CAUTION: This maneuver is influenced by many factors like pilot skills, experience, reaction time, wind, presence of obstacles etc. Good situational awareness and pilot judgment is essential.



3.5.2 COMPLETE IN-FLIGHT POWER LOSS

If the power is lost at altitude, pitch down as necessary to establish best glide speed. While gliding toward a suitable landing area, attempt to identify the cause of the failure and correct it.

1	Best Glide Speed (flaps 0)	ESTABLISH 70 KIAS
----------	----------------------------	-------------------

- If time permits:

2	Motor restart in flight procedure (3.5.3)	ATTEMPT
----------	---	---------

- If restart is not effective:

3	Emergency landing procedure (3.9.1)	PERFORM
----------	-------------------------------------	---------

WARNING: High motor or power controller temperature may be indicative of an imminent complete propulsion system failure.

BEST GLIDE SPEED AND RATIO CONDITIONS:

Weight:	600 kg
Best Glide Speed - V_g (flaps 0):	70 KIAS
Max. Glide Ratio:	15:1



3.5.3 MOTOR RESTART IN FLIGHT

NOTE: The minimum height, at which a motor restart attempt can be made safely, is 1000 ft AAL.

Attempt to restart the motor in flight following these steps:

1	Power lever	CUT OFF
2	PWR EN Switch	OFF
3	MASTER Switch	OFF
4	PWR CTRL Circuit breaker	DISENGAGE

After 3 seconds:

5	PWR CTRL Circuit breaker	ENGAGE
6	MASTER SWITCH	ON
7	PWR EN Switch	ON
8	Power lever	SLOWLY INCREASE

- If restart is not effective:

9	Emergency landing procedure (3.9.1)	PERFORM
---	-------------------------------------	---------

3.5.4 PARTIAL POWER LOSS

Possible causes for a partial loss of power include power controller, system controller or power lever malfunctions, fluctuating RPM or power derating intervention due to engine overtemperature. Check EPSI570C/annunciator for indication of malfunctions or abnormalities, or presence of caution or warning messages.

NOTE: If partial power loss is accompanied by engine overtemperature caution messages, the power loss is due to power derating activation. Perform Engine overtemperature procedures (3.5.10).

NOTE: A damaged propeller may cause extremely rough operation. If an out-of-balance propeller is suspected, immediately shut down engine and perform Emergency landing procedure (3.9.1).

APPROVED



Partial power loss at take off

Partial power loss is most critical during take off. The time available to assess the situation is limited and the pilot has to react quickly.

If partial power loss happens during take off run, and conditions permit a safe stoppage, the pilot has to abort the take off.

If the take off can't be aborted, perform the following:

1	Power available	ASSESS
----------	-----------------	--------

NOTE: 35 kW is considered as minimum power that should be available for safe initial climb.

2	Airspeed	ESTABLISH V _x (57 KIAS)
3	Climb over the obstacles to safe altitude	PERFORM
4	Propulsion system parameters	CHECK/MONITOR
5	Land	AS SOON AS PRACTICAL

Partial power loss in flight

If a partial engine failure permits level flight, keep monitoring EPSI570C display/annunciator and instruments, and try to determine the cause of the power loss. Land at a suitable airfield as soon as practical.

If conditions do not permit safe level flight, move the power lever through the complete range to obtain the best operation possible and check the amount of available power. Use partial power as necessary to set up a forced landing pattern over a suitable landing field. Always be prepared for a complete power loss.



3.5.5 BATTERY DISCONNECTED

Single Battery Disconnection

Battery disconnection can be either manual, by disengaging the battery circuit breaker, or automatic, triggered by the system.

In case of automatic battery disconnection, the EPSI570C will display a warning message identifying which battery has been disconnected (F=Front or R=Rear) and the reason for disconnection.

NOTE: In case of automatic "battery f/r disconnected due to: overtemperature" see specific [Battery overtemperature procedures \(3.5.7\)](#).

EPSI570C message	Annunciator
BATTERY F/R DISCONNECTED DUE TO: OVERVOLTAGE / UNDERVOLTAGE / INTERLOCK ERROR / INTERNAL HW FAILURE (red)	 or 

General procedure in case of single battery disconnection:

1	Affected battery circuit breaker	DISENGAGE
2	Reduce power	AS MUCH AS POSSIBLE
3	SOC, RFT, Battery temperature	MONITOR
4	Land	AS SOON AS PRACTICAL

Subsequent to automatic battery disconnection, the following caution messages will also appear (the second caution will be visible after the acknowledgment of the first):

EPSI570C message	Annunciator
ONLY ONE BATTERY PACK IS ACTIVE (amber)	
BATTERY CURRENT NOT EQUAL (amber)	

APPROVED

PAGE
3-22

PIPISTREL

POH-128-00-40-001
PAGE REV. 0



Subsequent, and consequently, to battery circuit breaker disengagement (this action will cause loss of communication with the battery and parameters such as battery temperature and voltage will no longer be available - see Appendix 9-A1 for details), also the following caution message will appear:

EPI570C message	Annunciator
<p>BATTERY F/R NOT PRESENT <i>(amber)</i></p>	 <p>or</p>

WARNING: Battery disconnection will reduce the aircraft endurance drastically. Monitor the remaining SOC and the RFT, and react accordingly. If the SOC does not permit reaching an airfield, set up a forced landing pattern over a suitable landing field and perform Emergency landing procedure (3.9.1).

WARNING: Max 40 kW of power with one battery operative. However, in exceptional cases (i.e. traffic/obstacle avoidance), full throttle can be applied for a recommended maximum duration of 30 seconds. If possible, use power settings below 30 kW to avoid battery temperature increase or risk of disconnection due to undervoltage of the functional battery.

WARNING: Do not attempt to reconnect a battery that has been automatically or manually (by disengaging the circuit breaker) disconnected. After one battery is disconnected, the equal voltage between the two packs it's not guaranteed anymore. Reconnecting one battery may lead to high very dangerous balancing current between the two batteries.

Double Battery Disconnection

Double battery disconnection shall be considered a Complete in-flight power loss, and requires Emergency landing procedure (3.9.1), without motor power:

- | | |
|--|----------------|
| 1 Emergency landing procedure (3.9.1) | PERFORM |
|--|----------------|

WARNING: Do not attempt to reconnect a battery that has been automatically or manually (by disengaging the circuit breaker) disconnected.



3.5.6 BATTERY HIGH TEMPERATURE

If battery temperature enters the caution range (between 51°C and 57 °C), EPSI570C and annunciator will display the following caution message:

EPSI570C message	Annunciator
BATTERY F/R HIGH TEMPERATURE (amber)	 OR 

Perform the following:

1 Power Lever	Reduce < 30 kW
2 Battery temperature	MONITOR

- If battery temperature remains in the caution range:

3 Land	AS SOON AS PRACTICAL
---------------	----------------------

- If battery temperature continues to increase, exceeding 55°C, also the following message appears:

EPSI570C message	Annunciator
BATTERY F/R ABOUT TO DISCONNECT (amber)	 or 

NOTE: The procedure remains the same as for the previous caution message "BATTERY F/R HIGH TEMPERATURE".



3.5.7 BATTERY OVERTEMPERATURE

If battery temperatures continue to rise, entering the warning range (≥ 58 °C), the battery is automatically disconnected by the system. Expect the following message to appear:

EPSI570C message	Annunciator
<p>BATTERY F/R DISCONNECTED DUE TO OVERTEMPERATURE <i>(red)</i></p>	 <p>ANNUNCIATOR</p> <p>or</p> <p>ANNUNCIATOR</p>

Also expect the battery overtemperature warning light of the affected battery to illuminate (independent analog system):

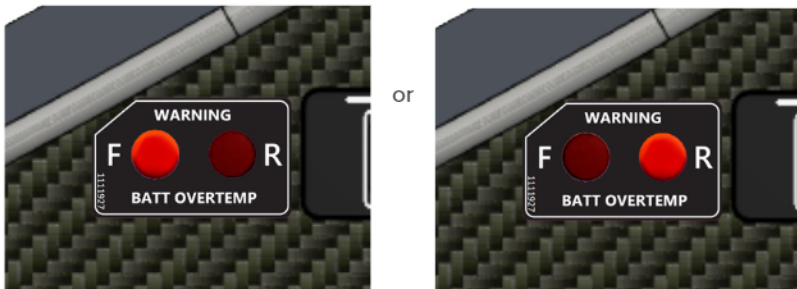

Perform the following:

1	Reduce power	AS MUCH AS POSSIBLE
2	Affected battery circuit breaker	DISENGAGE *
3	Caution messages on EPSI570C following battery disconnection/circuit breaker disengagement	ACKNOWLEDGE
4	SOC and RFT	MONITOR
5	Other battery temperature and parameters	MONITOR

- If warning is signalled by both alert systems (battery overtemperature warning lights AND EPSI warning message):



6	Land	IMMEDIATELY
7	Airplane	EVACUATE

- If warning is signalled by only one of the alert systems (battery overtemperature warning lights only OR EPSI warning only):

6	Land	AS SOON AS POSSIBLE
---	------	---------------------

* **NOTE:** After battery circuit breaker disengagement, communication with the battery is lost. The battery overtemp warning light will go off and battery parameters (such as temperature) will not be available (see Appendix 9-A1 for details). This does not mean that the overtemperature issue is solved.

CAUTION: Max 40 kW of power with one battery operative.

NOTE: in exceptional cases (i.e. traffic/obstacle avoidance) full throttle can be applied with single battery for a suggested maximum duration of 30 seconds. High power settings or prolonged full power applications may cause overtemperature or "disconnection due to undervoltage" of the remaining battery.

WARNING: Battery overtemperature may induce battery thermal runaway. An indication of possible ongoing thermal runaway is dense smoke or chemical smell from battery compartments. This situation is extremely dangerous and can lead to battery fire. **Any warning light activation or presence of chemical smell/smoke requires immediate attention.**

NOTE: See also Battery system fire procedure (3.6.2) for additional information about lithium battery fires and related procedures.

WARNING: Do not attempt to reconnect a battery that has been automatically or manually (by disengaging the circuit breaker) disconnected. After one battery is disconnected, equal voltage between the two packs is not guaranteed anymore. Reconnecting one battery may cause a high and very dangerous current surge between the two batteries

CAUTION: Do not re-connect or use the overheated battery after landing. Contact CAMO/CAO.



3.5.8 BATTERY NOT PRESENT

Single battery loss of communication

EPSI570C message	Annunciator
BATTERY F/R NOT PRESENT <i>(amber)</i>	 or 

1 Single battery disconnection procedure (3.5.5)	PERFORM
---	----------------

Communication loss with one battery is indicated by a single caution message. Affected battery information (SOC, temperature) is not available and EPSI battery parameters are covered by a red cross as shown in Section 9-A1. The battery can supply power, but can't be monitored. A precautionary manual disconnection is required (HV BATT F/R circuit breaker disengagement), applying Single battery disconnection procedure (3.5.5).

Double battery loss of communication

EPSI570C message	Annunciator
BATTERY F NOT PRESENT <i>(amber)</i> BATTERY R NOT PRESENT <i>(amber)</i>	

1 Reduce power	AS MUCH AS POSSIBLE
2 Annunciator/ Batt warning lights	MONITOR
3 Land	AS SOON AS PRACTICAL *

A total communication loss with both batteries is signalled by two caution messages. Red crosses appear over the parameters of both batteries.

*** CAUTION:** SOC and RFT values are not available and residual endurance is difficult to assess, so excessive energy consumption could occur without the pilot realizing it. A power-off precautionary landing is recommended. Additionally, if batteries are below 15%SOC, the power for a go-around is not guaranteed.



3.5.9 ENGINE HIGH TEMPERATURE

If engine (motor or power controller) temperature enters the caution range (65 °C - 69 °C for power controller or 100 °C - 109 °C for the motor) the following caution message will be displayed on EPSI570C:

EPSI570C message	Annunciator
ENGINE HIGH TEMPERATURE <i>(amber)</i>	

1 Reduce power	AS MUCH AS POSSIBLE
2 Engine (motor or power controller) temperature	MONITOR
3 Engine coolant pump status	CHECK EPSI for failure messages

CAUTION: Engine temperature may increase due to engine coolant pump malfunction. Engine coolant pump malfunction is usually detected and signaled by a caution message (see 3.5.18). If the engine high temperature is caused by coolant pump failure expect temperatures to increase rapidly as soon as power is applied.

- If engine temperature remains in caution range:

4 Land	AS SOON AS PRACTICAL
---------------	----------------------

WARNING: High power settings when the engine temperature is inside caution range will lead to the temperature entering the warning range, followed by engine overtemperature warning message.

NOTE: If power controller or motor temperature sensor failure occurs, the mission has to be aborted. In this case, Coolant IN and Coolant OUT temperature values (EPSI570C – SYSTEM page) can help the pilot identify engine cooling malfunction if temperatures rise abnormally.



3.5.10 ENGINE OVERTEMPERATURE

If engine temperature continues to increase and enters the warning range (70 °C for power controller and 110 °C for the motor), expect the following warning message to appear:

EPSI570C message	Annunciator
ENGINE OVERTEMPERATURE <i>(red)</i>	

1	Reduce power	AS MUCH AS POSSIBLE
2	Engine (motor or power controller) temperature	MONITOR

CAUTION: If engine temperature reaches the warning range **power derating** is activated (see 7.6.4 for power derating description). Full power will be available again only after the temperatures have dropped out of the warning range. Expect imminent power cut to zero in case of high power usage!

- If partial power is still available and the engine coolant pump is functional, perform the following:

3	Land	AS SOON AS POSSIBLE
----------	------	---------------------

- if engine overtemperature is associated with "engine coolant pump failure" message (3.5.18), power will very likely be derated to zero in a few seconds after power application. The recommended procedure is the following:

3	Power lever	CUT OFF
4	Best glide speed (flaps 0)	70 KIAS
5	Land (emergency landing)	PREPARE TO LAND

NOTE: Avoid unnecessary power application. Residual power before final derating to 0 kW can be carefully used to adjust final approach path during the emergency landing final phase, or traffic/obstacle avoidance.

- if power is derated to zero:

3	Emergency landing procedure (3.9.1)	PERFORM
----------	-------------------------------------	---------



3.5.11 BATTERY OVERCURRENT

This message is usually associated with single battery operation and if the system detects excessive current drain from the functional battery.

The following caution message will appear on EPSI570C:

EPSI570C message	Annunciator
BATTERY F/R OVERCURRENT <i>(amber)</i>	

1 Reduce power	AS MUCH AS POSSIBLE
2 Battery status/current (of both batteries)	CHECK

- if both batteries are still connected (current of both batteries \neq 0 A):

3 Battery temperatures and currents	MONITOR
4 Land	AS SOON AS PRACTICAL

- if one battery is disconnected (current = 0 A) and has caused overcurrent of the other:

3 Circuit breaker of battery delivering 0 A	DISENGAGE
4 Single Battery disconnection procedure (3.5.5)	PERFORM

CAUTION: Abort mission if the message appears while on the ground.

3.5.12 LOW STATE OF CHARGE (LOW SOC)

Battery SOC is indicated on the EPSI570C with two bars showing SOC percentage for each battery pack.



SOC bars are green when SOC % is between 100% and 30%, and turn amber below 30%.

When SOC % is lower than 30%, expect the following caution message to appear:

EPSI570C message	Annunciator
SOC<30% <i>(amber)</i>	

1 Reduce power	AS MUCH AS POSSIBLE
2 Remaining SOC and RFT	MONITOR
3 Land	PREPARE TO LAND

NOTE: A normal mission must terminate with SOC \geq 30% at landing!

3.5.13 NO GO-AROUND AVAILABLE

If the flight continues and SOC% decreases to 15%, the following caution message appears:

EPSI570C message	Annunciator
NO GO-AROUND AVAILABLE <i>(amber)</i>	

CAUTION: The message above indicates that batteries are almost discharged and the remaining energy is only sufficient for a few minutes of flight. There is not enough energy left to perform a go-around safely.

1 Land	PREPARE TO LAND
---------------	-----------------

WARNING: If SOC < 15%, applying full power may cause battery voltage to drop and eventual battery disconnection.



3.5.14 BATTERY SOC ADJUSTED

Battery malfunction may cause the system to recalculate the battery SOC. The updated values might be different from the previous. Remaining Flight Time (RFT) may change as well.

NOTE: This is not the case for normal SOC decrease during flight.

After SOC% is recalculated, expect the following caution message:

EPSI570C message	Annunciator
BATTERY F/R SOC ADJUSTED <i>(amber)</i>	 or 

1 Updated SOC value	CHECK
2 SOC and RFT	MONITOR

CAUTION: The mission has to be re-planned according to new SOC and RFT values!

3.5.15 BATTERY CELL LOW VOLTAGE

When the system detects a low cell voltage in either of the battery packs, expect the following caution message to appear:

EPSI570C message	Annunciator
BATTERY F/R LOW CELL VOLTAGE <i>(amber)</i>	 or 



1	Reduce power	AS MUCH AS POSSIBLE
2	SOC and RFT	MONITOR

CAUTION: If power is not adequately reduced, expect the affected battery to be disconnected automatically due to undervoltage.

NOTE: The caution message is triggered when the system detects a minimum cell voltage below 3100 mV in either of the battery packs. Displayed SOC is linked to cell voltage. Expect also low SOC caution message (3.5.12) to appear with the message above. Battery voltage decreases rapidly, especially when high power is applied at low SOC.

- If the battery disconnects:

3	Single battery disconnection procedure (3.5.5)	PERFORM
---	--	---------

CAUTION: In the case of battery undervoltage/overvoltage do not recharge the battery. The battery has to be sent to an authorized maintenance organization for inspection. Contact CAMO/CAO after the flight.

3.5.16 BATTERY COOLANT PUMP FAILURE

When the system detects a failure of one or both battery coolant pumps, expect the following caution messages to appear:

EPSI570C message	Annunciator
BATTERY COOLANT PUMP 1/2 FAILURE (amber)	

Single battery coolant pump failure

- If a single coolant pump fails (one caution message, for pump 1 OR 2):

1	Battery temperatures	MONITOR
2	Flight	Continue normally



Double battery coolant pump failure

- If both coolant pumps fail (two caution messages, one for pump 1 AND one for pump 2:

1	Reduce power	AS MUCH AS POSSIBLE
2	Battery temperatures	MONITOR
3	Land	AS SOON AS PRACTICAL

NOTE: Contact CAMO/CAO after the flight.

CAUTION: High power settings with both pumps inoperative will cause a rapid increase of battery temperatures. It is recommended to avoid excessive use of power unless absolutely necessary (traffic or obstacle avoidance).

3.5.17 ENGINE COMMUNICATION FAILURE

In the case of engine communication failure, the power setting can't be adjusted by the pilot and will stay the same as it was before the communication loss. The pilot has to evaluate the situation and assess whether there's enough power available to sustain level flight or return to base.

Expect the following caution message to appear:

EPSI570C message	Annunciator
ENGINE COMMUNICATION FAILURE (<i>amber</i>)	

1	Power Available	ASSESS
---	-----------------	--------

CAUTION: if communication is lost at high power settings and power can't be reduced, this may result in high power system component temperatures.

Assess the power available to determine if it is possible to return to base or to reach an alternate airfield or a suitable landing area. When at gliding

APPROVED



distance from the elected landing site and when ready for a power-out approach, switch the motor off:

2	PWR CTRL circuit breaker	DISENGAGE
3	Emergency landing procedure (3.9.1)	PERFORM

NOTE: In the case of engine communication failure, all parameters related to the motor and power controller, including the parameters (RPM, kW) displayed on the Kanardia instrument installed in front of the left seat, are covered by a red cross (see Section 9-A1 for more details). The values displayed represent the last valid output. Engine temperatures and other parameters will not be available and can't be monitored. Be prepared to the possibility of engine temperature rising, if communication was lost at high power settings. Power derating and propeller overspeed protection will remain active.

3.5.18 ENGINE COOLANT PUMP FAILURE

Engine coolant pump failure causes engine temperatures to rise immediately as power is applied.

When the system detects a engine coolant pump failure, expect the following caution message to appear:

EPSI570C message	Annunciator
ENGINE COOLANT PUMP FAILURE (amber)	

React as follows:

1	Power lever	CUT OFF
2	Best glide speed (flaps 0)	70 KIAS
3	Engine (power controller and motor) temperatures	CHECK
4	Land (emergency landing)	PREPARE TO LAND

NOTE: Avoid unnecessary power application. Residual power before final



derating to 0 kW can be carefully used to adjust final approach path during the emergency landing final phase, or for traffic/obstacle avoidance.

NOTE: See also Engine high temperature/overtemperature procedures (3.5.9 and 3.5.10) for caution and warning messages associated with engine high temperature and overtemperature.

3.5.19 ELECTRICAL SYSTEM INSULATION FAILURE

When the system detects an electrical insulation failure between high voltage and low voltage systems/wirings, expect the following caution message to appear:

EPSI570C message	Annunciator
SYSTEM ISOLATION FAILURE <i>(amber)</i>	

1 Land

AS SOON AS
PRACTICAL

CAUTION: Contact CAMO/CAO after the flight. Any inspection/troubleshooting by the pilot shall be avoided as it could lead to lethal electrical shock.

3.5.20 DC/DC CONVERTER FAILURES (IN FLIGHT)

When the system detects an DC/DC converter failure, expect one of the following caution messages to appear:

EPSI570C message	Annunciator
DC/DC COMMUNICATION FAILURE <i>(amber)</i>	
DC/DC NOT WORKING <i>(amber)</i> (if RPM>300)	



The DC/DC converter is the system that recharges the auxiliary battery. If the auxiliary battery is not being recharged, it will discharge during flight and aircraft instruments and essential systems will eventually become inoperative.

CAUTION: The system controller is powered by a DC/DC converter/aux battery. Also motor power will eventually be lost when aux battery is discharged.

1	AUX BATTERY Voltage	MONITOR
2	Land	AS SOON AS PRACTICAL

NOTE: aux battery guarantees at least 30 minutes of power.

3.5.21 POWER LEVER COMMUNICATION FAILURE

In the case of power lever communication failure, the power setting can't be changed by the pilot and it will stay the same as it was before the communication loss. The pilot has to evaluate the situation and assess whether there's enough power available to sustain level flight or return to base.

Expect the following caution message to appear:

EPSI570C message	Annunciator
POWER LEVER COMMUNICATION FAILURE <i>(amber)</i>	

1	Power Available	ASSESS
2	Engine and Battery temperatures	MONITOR

Assess the power available to determine if it is possible to return to base or to reach an alternate airfield or a suitable landing area.



When at gliding distance from elected landing site and when ready for a power-out approach, switch the motor off:

3	PWR CTRL circuit breaker	DISENGAGE
4	Emergency Landing (3.9.1)	PERFORM

3.5.22 BATTERY CURRENT NOT EQUAL

If the system detects disproportionate current drain between the two batteries, the following caution message will appear on EPSI570C:

EPSI570C message	Annunciator
BATTERY CURRENT NOT EQUAL (<i>amber</i>)	

1	Reduce power	AS MUCH AS POSSIBLE
2	Land	AS SOON AS PRACTICAL

NOTE: Contact CAMO/CAO after the flight



3.6 FIRE IN FLIGHT

3.6.1 ENGINE FIRE IN FLIGHT

1	PWR EN switch	OFF
2	MASTER switch	OFF
3	BATT EN switch	OFF
4	BATT REAR & BATT FRONT circuit breakers	DISENGAGE
5	Door windows	OPEN
6	Side-slip maneuver in direction opposite to the fire.	IF POSSIBLE
7	Land (emergency landing without motor power)	AS SOON AS POSSIBLE
8	Airplane	EVACUATE

3.6.2 BATTERY SYSTEM FIRE

Indication of battery fire is dense smoke and a distinctive chemical smell. Fire can develop quickly and aggressively. A battery system fire will trigger warning and cautions similar to those in a battery high temperature emergencies (see section 3.5.6). Expect battery high/overtemperature cautions and warnings to appear on the EPSI570C display and annunciator. Also expect BATT OVERTEMP WARNING light/s to illuminate. Should you encounter battery fire during flight, react as follows:

1	Affected battery circuit breaker	DISENGAGE
2	Land	IMMEDIATELY
3	Airplane	EVACUATE
4	Long range water type fire extinguisher (if available)	ACTIVATE

CAUTION: After battery circuit breaker disengagement the battery overtemp warning light will go off. This does not mean that the overtemperature issue is solved.

WARNING: Be aware that lithium battery fires are extremely dangerous because they are self-sustaining! They are a result of a chemical reactions



and are impossible to extinguish. You can only prevent or delay fire propagation by continually cooling down the batteries and surrounding items with a copious amount of water.

WARNING: The aircraft should be under surveillance for at least 24h due to possible latent battery thermal runaway or late cell ignition.

3.6.3 COCKPIT FIRE IN FLIGHT

If the cause of the fire is apparent and accessible, try first to locate the source of the fire and isolate it by disengaging the affected system or circuit breaker. If this is not effective, use a fire extinguisher (if available) or any other means to extinguish flames and land as soon as possible. Opening the vents may feed the fire, but to avoid incapacitating the crew from smoke inhalation, it may be necessary to rid cabin of smoke or fire extinguishing.

1	PWR EN switch	OFF
2	BATT EN switch	OFF
3	AVIONICS switch	OFF
4	MASTER Switch	OFF
5	Fire Extinguisher (if available)	ACTIVATE

WARNING: Should the fire extinguisher contain Halon gas, its operation can be toxic, especially in a closed area. After extinguishing fire, ventilate cabin by opening air vents and unlatching door (if required).

If airflow is not sufficient to clear smoke or fumes from cabin:

3	Door vents	OPEN
---	------------	------

CAUTION: The door structure/hinge is not designed for intentional open-door operations. Be advised that the chance of door failure occurring is higher, as the airspeed at which the door is opened at increases.

4	Land (emergency)	IMMEDIATELY
---	------------------	-------------



3.7 SPINS

The airplane is not approved for intentional spins.

While the stall characteristics of the airplane make accidental entry into a spin extremely unlikely, spinning is possible. Spin entry can be avoided by using good airmanship: coordinated use of controls in turns, proper airspeed control and never abusing the flight controls with accelerated inputs when close to the stall.

If the controls are misapplied at the stall or abused accelerated inputs are made to the elevator, rudder and/or ailerons, an abrupt wing drop may be felt and a spiral or spin may be entered. In some cases it may be difficult to determine if the aircraft has entered a spiral or the beginning of a spin.

In any case, spin recovery technique is classic:

1	Power lever	CUT OFF
2	Rudder	Full deflection - opposite to the spin
3	Control stick	Push forward - to lower the nose and build speed

As rotation stops:

4	Rudder	Neutralize
5	Horizontal flight	Resume - careful not to exceed g-load or airspeed limitations

NOTE: the aircraft is equipped with an aural and haptic stall warning system in the control stick handles, that are automatically activated when critical AOA is approached.

3.8 EXCEEDING V_{NE}

Should the V_{NE} be exceeded, reduce airspeed slowly and continue flying using gentle control deflections. Land safely as soon as possible and have the aircraft verified for airworthiness by authorized service personnel.



3.9 LANDING EMERGENCIES

If all attempts to restart the motor failed and an emergency landing is imminent, select a suitable field and prepare for landing.

A suitable field should be chosen as early as possible so that maximum time will be available to plan and execute the emergency landing. For emergency landings on unprepared surfaces, use full flaps if possible. Land on the main gear and hold the nose wheel off the ground as long as possible. If motor power is available, before attempting an "off airport" landing, fly over the landing area at a low but safe altitude to inspect the terrain for obstructions and surface conditions.

NOTE: Use of full (+2) flaps will reduce glide distance. Full flaps should not be selected until landing is assured.

3.9.1 EMERGENCY LANDING

1	Best Glide Speed	70 KIAS (flaps 0)
2	PWR CTRL circuit breaker	DISENGAGE
3	BATT FRONT & BATT REAR circuit breakers	DISENGAGE
4	Seat Belts	SECURED

Select a suitable field and prepare for the landing.

5	Flaps (when landing is assured)	+2
---	---------------------------------	----

If time permits:

6	Radio	Transmit (121.5 MHz) MAYDAY, giving location and intentions
7	Transponder	SQUAWK 7700
8	ELT Switch	ON (if necessary)

NOTE: ELT transmission can be deactivated by resetting either the remote switch or the ELT control switch to ARM/OFF position. Please see [2] for additional details.



3.9.2 DITCHING

1	Best Glide Speed	70 KIAS (flaps 0)
2	Power lever	CUT OFF
3	BATT FRONT circuit breaker	DISENGAGE
4	BATT REAR circuit breaker	DISENGAGE
5	Life vests	CHECK
6	Loose items in cabin	SECURE
7	Seat belts	CHECK SECURED AND TIGHTEN
8	Radio	Transmit (121.5 MHz) MAYDAY
9	Transponder	SQUAWK 7700
10	ELT switch	ON
11	Approach	High seas, high wind: into the wind. Light wind, heavy swells: parallel to the swells
12	Doors	OPEN
13	AUX BATT circuit breaker	DISENGAGE
14	Flaps	+2
15	Landing at the lowest possible speed	PERFORM
16	Seat belts	Release immediately
17	Airplane	EVACUATE
18	Life vest and raft	Inflate when outside the cabin
19	Flotation Devices	INFLATE WHEN CLEAR OF AIRPLANE

NOTE: If available, life preservers should be donned and life raft should be prepared for immediate evacuation upon touchdown. Consider OPENING a door prior to assuming the emergency landing body position in order to provide a ready escape path.



It may be necessary to allow some cabin flooding to equalize pressure on the doors. If the doors cannot be opened, break out the windows and crawl through the opening.

3.9.3 LANDING WITH A DEFECTIVE MAIN LANDING GEAR TIRE

- 1 Land the airplane at the edge of the runway that is located on the side of the intact tire, so that changes in direction during roll-out due to the braking action of the defective tire can be corrected on the runway.
- 2 Land with the wing low on the side of the intact tire.
- 3 Direction should be maintained using the rudder. This should be supported by use of the brake. It is possible that the brake must be applied strongly - if necessary to the point where the wheel locks.

CAUTION: A defective tire is not easy to detect. The damage normally occurs during take off or landing and is hardly noticeable during fast taxiing. It is only during the lower taxiing speeds that a tendency to swerve occurs.

3.9.4 LANDING WITH DEFECTIVE BRAKES

Brake system deficiency is usually detected only after touch down, during ground roll deceleration phase. If brakes are inefficient:

1	Seat belts	CHECK FASTENED AND TIGHTENED
2	Master Switch	OFF
3	PWR CTRL circuit breaker	DISENGAGE

In case of single brake failure, release immediately brake pressure to avoid swerve due to asymmetric braking. Only if necessary apply very light pressure on the brakes, using nose wheel steering to compensate asymmetric braking.

Steer the aircraft gently during deceleration. Once the aircraft has stopped, restart the power and vacate the runway at low speed and using low power settings.



3.10 EPSI570C DISPLAY FAILURE

NOTE: All propulsion system protection features will remain operative in the case of EPSI570C failure. Propulsion system temperatures and other system parameters can't be monitored. Precautionary use of low power settings is recommended.

Total EPSI570C display failure (hardware failure)

- In the event of EPSI570C display failure (i.e. black or malfunctioning screen):

1	Reduce power	AS MUCH AS POSSIBLE
2	EPSI Circuit Breaker	DISENGAGE
3	Annunciator/ batt warning lights	MONITOR
4	Land	AS SOON AS PRACTICAL *

CAUTION: In case of EPSI hardware failure, stall warning system might be inoperative.

NOTE: If the failure only affects the EPSI display, the Kanardia instrument serves as backup for kW and RPM indication, and can be used together with other remaining instruments for the continuation of the flight (ASI, ALT, Compass, VSI, Horis).

Partial EPSI570C display failure (loss of communication)

- In the event of EPSI570C communication failure (see also [page 9-A1-15](#)):

1	Reduce power	AS MUCH AS POSSIBLE
2	Annunciator/ batt warning lights	MONITOR
3	Land	AS SOON AS PRACTICAL *

NOTE: In case of EPSI570C communication failure, the Kanardia instrument serves as backup for kW and RPM indication, and can be used together with other remaining instruments for the continuation of the flight (ASI, ALT, Compass, VSI, Horis).

* **CAUTION:** SOC and RFT values are not available and residual endurance is difficult to asses, so excessive energy consumption could occur without the pilot realizing it. A power-off precautionary landing is recommended. Additionally, if batteries are below 15%SOC, the power for a go-around is not guaranteed.



3.11 RADIO COMMUNICATION FAILURE

1	Switches, Controls	CHECK
2	Frequency	CHANGE
3	COM Circuit Breaker	CHECK
4	Headset	CHANGE
5	Transmission	ATTEMPT
if unsuccessful:		
6	transponder	SQUAWK 7600

3.12 PITOT STATIC SYSTEM MALFUNCTION

Static Source Blocked

If erroneous readings of the static source instruments (airspeed, altimeter and vertical speed) are suspected, the information from the GPS system should be used for situational awareness.

NOTE: Referring to the GPS for flying, adjust indicated airspeed during climb or approach. Use +10 KTS on top of standard procedure as guidance and observe the wind situation.

Pitot Tube Blocked

If only the airspeed indicator is providing erroneous information, and in icing conditions, the most probable cause is pitot ice. Descend into warmer air. If an approach must be made with a blocked pitot tube, use known pitch and power settings and the GPS ground speed indicator, taking surface winds into account.

1	Ground speed indicator	+10 KTS for procedures, observe winds
---	------------------------	---------------------------------------



3.13 ELECTRIC TRIM FAILURE

Any failure or malfunction of the electric trim can be overridden by use of the control stick. If runaway trim servo is the problem, cut the circuit by disengaging the TRIM circuit breaker and land as soon as practical.

1	Airplane Control	GRASP STICK, MAINTAIN MANUALLY
If problem is not corrected:		
2	TRIM Circuit Breaker	DISENGAGE
3	Power Lever	AS REQUIRED
4	Control Stick	MANUALLY HOLD PRESSURE
5	Land	AS SOON AS PRACTICAL

3.14 AUXILIARY BATTERY FAILURE

The auxiliary (aux) battery disconnects automatically in the case of malfunction, overvoltage and/or undervoltage. The low voltage systems are still powered by the DC/DC converter.

Expect the following caution message to appear:

EPSI570C message	Annunciator
AUXILIARY BATTERY FAILURE <i>(amber)</i>	

1	Land	AS SOON AS PRACTICAL
----------	------	----------------------

CAUTION: Do not take off if AUX BATT has low voltage (< 12.8V).



3.15 ICE BUILD-UP

Turn back or change altitude to exit icing conditions. Consider lateral or vertical path reversal to return to last “known good” flight conditions. Maintain VFR flight! Watch for signs of icing on the pitot tube. In case of pneumatic instrument failures, use the GPS information to reference to approximate ground speed. Plan the landing at the nearest airport, or a suitable off airport landing site in case of an extremely rapid ice build-up. Increase the speed to avoid stall.

Maneuver the airplane gently and leave the flaps retracted. When ice is built-up at the horizontal stabilizer, the change of pitching moment due to flaps extension may result of loss of elevator control. Approach at elevated speeds (+15 KTS, also if using the GPS as a reference).

WARNING: Failure to act quickly may result in an unrecoverable icing encounter.



3.16

CHECKLISTS

EMERGENCY PROCEDURES

NOTE: Use of the following checklists is not obligatory
and at the discretion of the owner/operator.



This page is intentionally left blank.

GROUND EMERGENCIES

ENGINE SYSTEM FIRE ON THE GROUND

Come to a complete standstill	-
MASTER switch	OFF
BATT EN switch	OFF
PWR EN switch	OFF
BATT REAR/BATT FRONT circuit breakers	DISENGAGE
PWR CTRL circuit breaker	DISENGAGE
Emergency ground egress procedure	PERFORM

BATTERY FIRE ON THE GROUND

Come to a complete standstill	-
MASTER switch	OFF
BATT EN switch	OFF
BATT REAR/BATT FRONT circuit breakers	DISENGAGE
Emergency ground egress procedure	PERFORM

EMERGENCY ENGINE SHUTDOWN ON GROUND

Power Lever	CUT OFF
MASTER Switch	OFF
BATT EN Switch	OFF
PWR EN Switch	OFF
PWR CTRL Circuit breaker	DISENGAGE

EMERGENCY GROUND EGRESS

Engine	SHUTDOWN
Parking brake	ENGAGE
Seat belts	RELEASE
Airplane	EXIT
Vicinity of airplane	EVACUATE

MASTER
CAUTION

MASTER
WARNING

ANY CAUTION / WARNING MESSAGE AT TAKE OFF

If take off run is not initiated yet:

DO NOT TAKE OFF

*If the take off run is initiated and conditions (speed,
available runway) permit safe aircraft stoppage:*

Come to a complete standstill	PERFORM
MASTER switch	OFF
Affected battery circuit breaker (if message is battery-related)	DISENGAGE
Taxi off the runway (using low power setting)	PERFORM
Emergency shutdown procedure	PERFORM

If conditions do not permit safe aircraft stoppage:

Take off	CONTINUE
Land	AS SOON AS PRACTICAL

POWER LEVER / ENGINE COMMUNICATION FAILURE



CAUTION:

POWER LEVER COMMUNICATION FAILURE (amber)

or

ENGINE COMMUNICATION FAILURE (amber)

If take off run is not initiated yet:

PWR CTRL circuit breaker	DISENGAGE
--------------------------	-----------

Power lever	CUT OFF
-------------	---------

Shutdown procedure	PERFORM
--------------------	---------

Parking procedure	PERFORM
-------------------	---------

*If take off run is initiated and there is enough runway to stop the aircraft
or power/speed is not sufficient for lift off and climb*

PWR CTRL circuit breaker	DISENGAGE
--------------------------	-----------

Power lever	CUT OFF
-------------	---------

Come to a complete standstill	PERFORM
-------------------------------	---------

Shutdown procedure	PERFORM
--------------------	---------

Push the aircraft off the runway	PERFORM
----------------------------------	---------

Parking procedure	PERFORM
-------------------	---------

If there is not enough runway available to stop, and power/speed is sufficient for lift off and climb:

perform Engine / power lever communication failure (in flight) procedures

IN FLIGHT EMERGENCIES

COMPLETE POWER LOSS AFTER TAKE OFF

Best Glide or Landing Speed (as appropriate)	ESTABLISH (70 - 60 KIAS)
BATT REAR/BATT FRONT circuit breakers	DISENGAGE
PWR CTRL Circuit breaker	DISENGAGE
Flaps	AS REQUIRED
Land (emergency landing)	PREPARE TO LAND

COMPLETE IN-FLIGHT POWER LOSS

Best Glide speed (flaps 0)	70 KIAS
----------------------------	---------

If time/altitude permits:

Motor restart in flight procedure	ATTEMPT
-----------------------------------	---------

If restart is not effective:

Emergency landing procedure	PERFORM
-----------------------------	---------

MOTOR RESTART IN FLIGHT

Power lever	CUT OFF
-------------	---------

PWR EN Switch	OFF
---------------	-----

MASTER Switch	OFF
---------------	-----

PWR CTRL Circuit breaker	DISENGAGE
--------------------------	-----------

After 3 seconds:

PWR CTRL Circuit breaker	ENGAGE
--------------------------	--------

MASTER switch	ON
---------------	----

PWR EN switch	ON
---------------	----

Power lever	Slowly increase
-------------	-----------------

If restart is not effective:

Emergency landing procedure	PERFORM
-----------------------------	---------

PARTIAL POWER LOSS (at take off)

If it is not possible to stop the aircraft before the end of the runway, lift off and:

Power available	ASSESS (at least 35 kW for safe climb)
Airspeed	V _x (57 KIAS)
Climb over obstacles	PERFORM
Propulsion system parameters (EPSI)	CHECK/MONITOR
Land	AS SOON AS PRACTICAL

PARTIAL POWER LOSS (in flight)

EPSI570C/annunciator	CHECK for Caution/Warning messages
----------------------	------------------------------------

If conditions do not permit safe level flight:

Emergency landing procedure (use partial power as necessary)	PERFORM
--	---------

If conditions permit safe level flight:

EPSI570C and instruments	MONITOR
Land	AS SOON AS PRACTICAL

BATTERY DISCONNECTED (single battery)



OR



WARNING:

BATTERY F/R DISCONNECTED DUE TO:
OVERVOLTAGE / UNDERVOLTAGE
/ INTERLOCK ERROR
/ INTERNAL HARDWARE FAILURE (red)

Affected battery circuit breaker	DISENGAGE
Other EPSI messages subsequent to disconnection	ACKNOWLEDGE
SOC, RFT, battery temperature	MONITOR
Reduce power	AS MUCH AS POSSIBLE
Land	AS SOON AS PRACTICAL

DOUBLE BATTERY DISCONNECTION

Emergency landing procedure	PERFORM
-----------------------------	---------

BATTERY HIGH TEMPERATURE (temperature in caution range)



OR



CAUTION:

BATTERY F/R HIGH TEMPERATURE (amber)

followed by (if temperature increases more):

BATTERY F/R ABOUT TO DISCONNECT (amber)

Power lever	Reduce <30 kW
-------------	---------------

Battery temperature	MONITOR
---------------------	---------

If battery temperature remains in the caution range:

Land	AS SOON AS PRACTICAL
------	----------------------

BATTERY OVERTEMPERATURE (temperature in warning range)



OR



WARNING:

**BATTERY F/R DISCONNECTED DUE TO:
OVERTEMPERATURE (red)**

Reduce power	AS MUCH AS POSSIBLE
--------------	---------------------

Affected battery circuit breaker	DISENGAGE
----------------------------------	-----------

Other EPSI messages subsequent to disconnection	ACKNOWLEDGE
---	-------------

SOC and RFT	MONITOR
-------------	---------

If battery overtemperature is signalled by Warning light AND EPSI caution message:

Land	IMMEDIATELY
------	-------------

Airplane	EVACUATE
----------	----------

If battery overtemperature is signalled by on system only (Warning light OR EPSI caution message):

Land	AS SOON AS POSSIBLE
------	---------------------

BATTERY NOT PRESENT (single batt)



OR



CAUTION:

BATTERY F/R NOT PRESENT (amber)

Affected battery circuit breaker	DISENGAGE
Other EPSI messages subsequent to disconnection	ACKNOWLEDGE
SOC, RFT, battery temperature	MONITOR
Reduce power	AS MUCH AS POSSIBLE
Land	AS SOON AS PRACTICAL

BATTERY NOT PRESENT (double batt)



+



CAUTION:

BATTERY F NOT PRESENT (amber)

and

BATTERY R NOT PRESENT (amber)

Reduce power	AS MUCH AS POSSIBLE
Annunciator/ batt warning lights	MONITOR
Land	AS SOON AS PRACTICAL

A power-off precautionary landing is recommended (SOC not available)

ENGINE HIGH TEMPERATURE
(temperature in caution range)



CAUTION:

ENGINE HIGH TEMPERATURE (amber)

Reduce power AS MUCH AS POSSIBLE

Engine temperature MONITOR

Engine cooling pump status (EPSI messages) CHECK EPSI for failure messages

If engine temperature remains in caution range:

Land AS SOON AS PRACTICAL

ENGINE OVERTEMPERATURE
(temperature in warning range,
continues from Engine High Temperature)



WARNING:

ENGINE OVERTEMPERATURE (red)

CAUTION: POWER DERATING ACTIVE

If partial power is still available and the engine coolant pump is functional, perform the following:

Land AS SOON AS POSSIBLE

*If also coolant pump is not functional
(caution message - engine coolant pump failure):*

Power lever CUT OFF
(use residual power on final)

Best Glide Speed 70 KIAS (flaps 0)

Land (emergency landing) PREPARE TO LAND

If power is derated to zero:

Emergency landing procedure PERFORM

BATTERY OVERCURRENT



OR



CAUTION:

BATTERY F/R OVERCURRENT (amber)

Reduce power	AS MUCH AS POSSIBLE
Battery status/current (of both batteries)	CHECK <i>if both batteries are still connected (current of both batteries \neq 0 A):</i>
Battery temperatures and currents	MONITOR
Land	AS SOON AS PRACTICAL <i>if one battery is disconnected (current = 0A), and caused overcurrent to the other:</i>
Circuit breaker of battery delivering 0 A	DISENGAGE
Single Battery disconnection procedure	PERFORM

LOW STATE OF CHARGE (SOC)



+



CAUTION:

SOC < 30% (amber)

Reduce power	AS MUCH AS POSSIBLE
Remaining SOC and RFT	MONITOR
Land	PREPARE TO LAND

NO GO-AROUND AVAILABLE

MASTER
CAUTION

CAUTION:

NO GO-AROUND AVAILABLE (amber)

Land

PREPARE TO LAND

WARNING: If SOC < 15%, applying full power may cause battery voltage to drop and eventual battery disconnection

BATTERY SOC ADJUSTED

MASTER
CAUTION



OR



CAUTION:

BATTERY F/R SOC ADJUSTED (amber)

Updated SOC value

CHECK

SOC and RFT

MONITOR

BATTERY CELL LOW VOLTAGE

MASTER
CAUTION



OR



CAUTION:

BATTERY F/R LOW CELL VOLTAGE (amber)

Reduce power

AS MUCH AS POSSIBLE

SOC and RFT

MONITOR

If affected battery is disconnected due to undervoltage:

Battery disconnected
(single batt) procedure

PERFORM

BATTERY COOLANT PUMP FAILURE

MASTER
CAUTION

CAUTION:

BATTERY COOLANT PUMP 1/2 FAILURE (amber)

If a single coolant pump fails (pump 1 or pump 2):

Battery temperatures	MONITOR
----------------------	---------

Flight	Continue normally
--------	-------------------

If both coolant pumps fail (two caution messages):

Reduce power	AS MUCH AS POSSIBLE
--------------	---------------------

Battery temperatures	MONITOR
----------------------	---------

Land	AS SOON AS PRACTICAL
------	-------------------------

ENGINE COMMUNICATION FAILURE

MASTER
CAUTION



CAUTION:

ENGINE COMMUNICATION FAILURE (amber)

Power available	ASSESS
-----------------	--------

*When at gliding distance from the elected landing site
and when ready for a power-out approach:*

PWR CTRL circuit breaker (motor will quit)	DISENGAGE
---	-----------

Emergency landing procedure	PERFORM
--------------------------------	---------

ENGINE COOLANT PUMP FAILURE



CAUTION:

ENGINE COOLANT PUMP FAILURE (amber)

Power lever	CUT OFF
Best glide speed	70 KIAS (flaps 0)
Engine temperatures	CHECK
Land (emergency)	PREPARE TO LAND (use residual power for obstacle avoidance only)

ELECTRICAL SYSTEM INSULATION FAILURE



CAUTION:

SYSTEM ISOLATION FAILURE (amber)

Land	AS SOON AS PRACTICAL
------	----------------------

CAUTION: Any inspection/troubleshooting by the pilot shall be avoided as it could lead to lethal electrical shock.

DC/DC CONVERTER FAILURES



CAUTION:

DC/DC COMMUNICATION FAILURE (amber)

or, if RPM >300:

DC/DC NOT WORKING (amber)

AUX BATTERY Voltage	MONITOR
Land	AS SOON AS PRACTICAL

POWER LEVER COMMUNICATION FAILURE

MASTER
CAUTION

CAUTION:

POWER LEVER COMMUNICATION FAILURE (amber)

Power available	ASSESS
-----------------	--------

Engine and Battery temperatures	MONITOR
---------------------------------	---------

*When at gliding distance from the elected landing site
and when ready for a power-out approach:*

PWR CTRL circuit breaker (motor will quit)	DISENGAGE
---	-----------

Emergency landing procedure	PERFORM
--------------------------------	---------

BATTERY CURRENT NOT EQUAL

MASTER
CAUTION

CAUTION:

BATTERY CURRENT NOT EQUAL (amber)

Reduce power	AS MUCH AS POSSIBLE
--------------	------------------------

Land	AS SOON AS PRACTICAL
------	-------------------------

AUXILIARY BATTERY FAILURE

MASTER
CAUTION

CAUTION:

AUXILIARY BATTERY FAILURE (amber)

Land	AS SOON AS PRACTICAL
------	-------------------------

FIRE IN FLIGHT

ENGINE FIRE IN FLIGHT

PWR EN switch	OFF
MASTER switch	OFF
BATT EN switch	OFF
BATT REAR & BATT FRONT circuit breakers	DISENGAGE
Door windows	OPEN
Side-slip - direction opposite to the fire	IF POSSIBLE
Land (emergency)	AS SOON AS POSSIBLE
Airplane	EVACUATE

BATTERY SYSTEM FIRE

Affected battery circuit breaker	DISENGAGE
Land	IMMEDIATELY
Airplane	EVACUATE
Long range water type fire extinguisher (if available)	ACTIVATE

COCKPIT FIRE

ALL Switches	OFF
Fire Extinguisher (if available)	ACTIVATE
Door vents	OPEN
Land (emergency)	IMMEDIATELY



SPIN	
Power lever	CUT OFF
Rudder	Full deflection, direction opposite to the spin
Control stick	Push forward
<i>As rotation stops:</i>	
Rudder	Neutralize
Horizontal flight	Resume, careful not exceeding speed/g limits



LANDING EMERGENCIES

EMERGENCY LANDING

Best Glide Speed	70 KIAS (flaps 0)
------------------	-------------------

PWR CTRL circuit breaker	DISENGAGE
--------------------------	-----------

BATT FRONT & BATT REAR circuit breakers	DISENGAGE
---	-----------

Seat Belts	SECURED
------------	---------

Flaps (when landing is assured)	+2
------------------------------------	----

If time permits:

Radio	Transmit (121.5 MHz) MAYDAY
-------	--------------------------------

Transponder	SQUAWK 7700
-------------	-------------

ELT Switch	ON (if necessary)
------------	-------------------

DITCHING

Best Glide Speed	70 KIAS (flaps 0)
------------------	-------------------

Power lever	CUT OFF
-------------	---------

BATT FRONT & BATT REAR circuit breakers	DISENGAGE
---	-----------

Life vests	CHECK
------------	-------

Loose items in cabin	Secure
----------------------	--------

Seat belts	CHECK SECURED AND TIGHTEN
------------	------------------------------

Radio	Transmit (121.5 MHz) MAYDAY
-------	--------------------------------

Transponder	SQUAWK 7700
-------------	-------------

Continue →

DITCHING (continue)

ELT switch	ON
Approach direction	High seas, high wind: into the wind. Light wind, heavy swells: parallel to the swells
Doors	OPEN
AUX BATT circuit breaker	DISENGAGE
Flaps	+2
Landing at the lowest possible speed	PERFORM
Seat belts	Release immediately
Airplane	EVACUATE
Life vest and raft	Inflate when outside the cabin
Flotation Devices	INFLATE WHEN CLEAR OF AIRPLANE

LANDING WITH DEFECTIVE BRAKES

Seat belts	CHECK FASTENED AND TIGHTENED
Master Switch	OFF
PWR CTRL circuit breaker	DISENGAGE
Steer gently	-
<i>Once the aircraft has stopped:</i>	
Engine	Re-start
Vacate runway at low speed/low power setting	PERFORM

EPSI570C DISPLAY FAILURE

Display failure (black screen, hardware malfunction):

Reduce power	AS MUCH AS POSSIBLE
EPSI Circuit Breaker	DISENGAGE
Annunciator/ Batt Overtemp warning lights	MONITOR
Land	AS SOON AS PRACTICAL

EPSI570C communication failure:

Reduce power	AS MUCH AS POSSIBLE
Annunciator/ Batt Overtemp warning lights	MONITOR
Land	AS SOON AS PRACTICAL

RADIO COMMUNICATION FAILURE

Switches, Controls	CHECK
Frequency	CHANGE
COM Circuit Breaker	CHECK
Headset	CHANGE
Transmission	ATTEMPT

If unsuccessful:

Transponder	SQUAWK 7600
-------------	-------------

PITOT STATIC MALFUNCTION

Refer to GPS for flying:

Ground speed indicator	+10 KTS for procedures, observe winds
------------------------	--



ELECTRIC TRIM FAILURE	
Airplane Control	GRASP STICK, MAINTAIN MANUALLY
TRIM Circuit Breaker	DISENGAGE
Power Lever	AS REQUIRED
Control Stick	Manually hold pressure
Land	AS SOON AS PRACTICAL





This page is intentionally left blank.

SECTION

4



SECTION 4 – NORMAL PROCEDURES

TABLE OF CONTENTS

PART	SUBJECT	PAGE NUMBER
4.1	INTRODUCTION	4-3
4.2	AIRSPEEDS FOR NORMAL OPERATIONS	4-3
4.3	PREFLIGHT INSPECTION Preflight Walk-Around	4-4
4.4	STARTING MOTOR Before Starting Motor Starting the Motor - Before Taxiing Taxiing Before Take off	4-8
4.5	TAKE OFF Take off Run and Flap settings	4-12
4.6	CLIMBING	4-13
4.7	CRUISE	4-13
4.8	DESCENT / APPROACH	4-13
4.9	LANDING	4-14
4.10	BALKED LANDING/GO AROUND	4-15
4.11	AFTER LANDING	4-15
4.12	SHUT DOWN	4-16
4.13	PARKING	4-16
4.14	SOFT FIELD OPERATIONS	4-16
4.15	STALL	4-17
4.16	NORMAL PROCEDURES - CHECK-LIST	4-19



4.1 INTRODUCTION

This section includes all procedures for normal operation.

4.2 AIRSPEEDS FOR NORMAL OPERATION

Unless otherwise noted, the following speeds are based on a maximum mass of 600 kg and may be used for any lower actual mass. However, to achieve the performance specified in Section 5 for take off and landing distance, the speed correction, adjusted to the particular mass, must be used.

TAKE OFF ROTATION		
Normal	Flaps +1	50 KIAS

CLIMB		
Normal	Flaps 0	75 KIAS
Best rate of climb (SL) - V_y	Flaps 0	75 KIAS
Best angle of climb (SL) - V_x	Flaps 0	57 KIAS

LANDING APPROACH		
Normal approach	Flaps +1	65 KIAS
Normal approach	Flaps +2	60 KIAS

GO AROUND		
Full power	Flaps as practical	59 KIAS

Maximum demonstrated crosswind velocity

Take off or landing	15 kts (7.5 m/s)
---------------------	------------------



4.3 PREFLIGHT INSPECTION

Before carrying out preflight inspections, ensure that all required maintenance has been performed. Review your flight plan and compute weight and balance.

NOTE: Throughout the walk-around: check all visible hinges, hinge pins, and bolts for security; check skin for damage, condition, impact damage or bumps, paint separations and evidence of cracks or delamination, check all control surfaces for proper movement and excessive free play.

In cold weather, remove all frost, ice, or snow from fuselage, wing, stabilizers and control surfaces. Ensure that control surfaces are free of ice or debris. Check that wheels are free of snow and ice accumulation.

NOTE: It is important to remove the upper engine cowling and crew seats for a general inspection at least before the first flight of the day. Special attention should be paid to any signs of leakage. Coolant level should be checked through the inspection windows on engine and battery coolant expansion tanks, and absence of air bubbles should be verified in transparent hoses. All visible electric and control cable connections should be checked for wear. All drain holes shall be verified clean and unobstructed.

4.3.1 PREFLIGHT WALK-AROUND

CABIN: PRE- WALK AROUND CHECK		
1	Doors	UNLOCK/OPEN/CLOSE/SECURE
2	ALL switches	CHECK OFF
3	Parking brake	ENGAGE
4	Main wing spars and connectors	CHECK
5	Instrument panel, EPSI570C and all other instruments	CHECK condition, displays OK, EPSI USB cap present
6	Headphones/microphones	Connected
7	Required documents	ON BOARD
8	ELT switches (remote switch and transmitter)	CHECK both in ARM/OFF position (armed)
9	Flight Controls and flap handle	CHECK free and correct



10	MASTER switch	ON
11	Batt overtemp warning lights - Annunciator - Haptic stall warning	CHECK SELFTEST (see section 7.6.7 for details)
12	AVIONICS switch	ON
13	Circuit breakers	CHECK ENGAGED
14	Instruments	CHECK functional
15	Elevator trim	Centered
16	Power lever	CUT OFF
17	BAT EN switch	ON
18	PWR EN switch	ON
19	EPSI570C display* / annunciator	Flight/System page available, CHECK no warnings/cautions
20	AUX BATT Voltage on EPSI570C	CHECK > 13V
21	Battery %SOC, SOH, temperature and status "ACTIVE"(system page)	CHECK
22	Engine (power controller and motor) temperatures	CHECK
23	BAT EN switch	OFF
24	PWR EN switch	OFF
25	AVIONICS switch	OFF
26	MASTER switch	OFF

* **CAUTION:** Do not take off if normal FLIGHT/SYSTEM operation mode is not available and functional on EPSI570C display.

LEFT FUSELAGE		
1	COM antenna (top)	Condition and attachment
2	Wing / fuselage seal	CHECK
3	XPDR antenna (underside)	Condition and attachment
4	Static pressure port	CHECK for blockage
5	Battery cooling system inlet/outlet	CHECK no obstructions
6	Rear battery compartment panel	CHECK closed



SECTION 4

NORMAL PROCEDURES

LEFT MAIN LANDING GEAR		
1	Landing gear	General condition
2	Tire	Condition, inflation, and wear
3	Wheel and brakes	Fluid leaks, evidence of overheating, general condition and wear
4	Chocks and tie down rings/ropes	Remove

LEFT WING		
1	Leading edge	CHECK condition
2	Tip	CHECK condition
4	Flaperon	Condition, attachment, movement
5	Flaperon gap seal	Condition, no wrinkles
6	Hinges, nuts	CHECK condition - Secured

EMPENNAGE		
1	Tie down rope	Remove
2	Horizontal and vertical stabilizers	CHECK condition
3	Elevator and elevator U-piece	Condition and movement
4	Rudder	Condition and movement
5	Attachment bolts, hinges, nuts	CHECK condition - Secured

RIGHT FUSELAGE		
1	Static pressure port	Check for blockage
2	Wing / fuselage seal	CHECK
3	Door lock	CHECK Unlocked
4	Battery exhaust outlet	CHECK no thermal runaway
5	ELT antenna (top)	Condition and attachment

RIGHT WING		
1	Flaperon	Condition, security and movement
2	Flaperon gap seal	Security, no wrinkles
3	Hinges, nuts	CHECK condition - Secured
4	Tip	CHECK condition
5	Leading edge	CHECK condition



6	Pitot tube	Cover removed, attachment, tube clear
----------	------------	---------------------------------------

RIGHT MAIN LANDING GEAR

1	Landing gear	General condition
2	Tire	Condition, inflation, and wear
3	Wheel and brakes	Fluid leaks, evidence of overheating, general condition and wear
4	Chocks and tie down rings/ropes	Remove

PROPELLER AND COWLINGS AREA

1	Cowlings	Attachment secured
2	Propeller	CHECK condition
3	Hub and blades	CHECK condition and blade pitch marker paint at blade roots
4	Spinner	CHECK condition
5	Propeller/spinner bolts and screws	CHECK
6	Air inlets, outlets	Unobstructed
7	Charging port door	Closed and latched

WARNING: Keep clear of propeller rotation plane. Do not allow others to approach propeller.

NOTE: Detailed information about propeller can be found in the propeller operator's manual [4].

MOTOR AND NOSE LANDING GEAR AREA

1	Strut	CHECK condition
2	Nose landing gear	CHECK condition
3	Wheel and tire	CHECK condition
4	Shock absorber	CHECK/TEST
5	Front battery compartment panels	CHECK closed
6	Battery exhaust outlet	CHECK no thermal runaway



4.4 STARTING MOTOR

4.4.1 BEFORE STARTING MOTOR

CAUTION: To ensure proper and safe use of the aircraft it is essential to familiarize yourself with the motor's limitations and motor manufacturer's safety warnings. Additional details and information can be found in Engine operator's manual [3].

Before motor start-up make sure the area in front of the aircraft is clear. Check SOC to make sure there is sufficient battery power for the planned duration of flight (in any case $\geq 50\%$ SOC) and landing with 30% residual SOC.

BEFORE START-UP		
1	MASTER switch	CHECK OFF
2	AVIONICS switch	CHECK OFF
3	BATT EN switch	CHECK OFF
4	PWR EN switch	CHECK OFF
5	Aircraft log book	FILLED
6	Doors	CHECK LATCHED AND SECURED
7	Position of rudder pedals	SET and LOCKED
8	Flight Controls	FULL, FREE AND CORRECT
9	Seat belts	ADJUSTED AND FASTENED
10	Power lever	CUT OFF
11	Parking brake	ENGAGE
12	Circuit breakers	CHECK ALL ENGAGED
13	ELT remote switch*	CHECK "ARM/OFF" position (armed)

* **NOTE:** Periodical testing of ELT operation is required (once a month advised, but not more than once per week). Please see OEM [2] for details about testing procedure.



4.4.2 STARTING THE MOTOR - BEFORE TAXIING

1	MASTER switch	ON
2	Batt overtemp warning lights - Annunciator - Haptic stall warning	CHECK SELFTEST (see section 7.6.7 for details)

NOTE: SELFTEST procedure and selftest pass criteria are described in Section 7.6.7. If selftest is not passed, do not take off and contact CAMO/CAO.

3	AVIONICS switch	ON
4	Battery SOC on EPSI570C	CHECK sufficient for flight, and $\geq 50\%$

CAUTION: Do not take off if SOC is $< 50\%$! Recharge the batteries.

5	Batteries SOH on EPSI570C	CHECK $> 0\%$
---	---------------------------	---------------

CAUTION: Do not take off if SOH=0%! Contact CAMO/CAO.

6	AUX Batt voltage on EPSI570C	CHECK $> 13V$
7	Radio	TURN ON AND SET FREQUENCY
8	Transponder	TURN ON AND SET CODE
9	EPSI570C - system page:	CHECK BATTERIES 'READY'
10	Power lever	CUT OFF
11	BATT EN switch	ON
12	PWR EN switch	ON
13	EPSI570C - system page:	CHECK BATTERIES 'ACTIVE'
14	Time	NOTED
15	Parking brake	DISENGAGE
16	Power lever	INCREASE FOR TAXI

NOTE: If motor doesn't start running, check the position of the power lever. It will only start running after power is applied from the CUT OFF position.



SECTION 4

NORMAL PROCEDURES

4.4.3 TAXIING

When taxiing, directional control is accomplished with pedal deflection and with the use of toe activated brakes when necessary. Use only as much power as is necessary to achieve forward movement. Deceleration or taxi speed control using brakes, but without a reduction in power, will result in increased brake temperature and may, in extreme cases, cause fire. Taxi over loose gravel at low motor speed to avoid damage to the propeller tips. During the taxi, use minimum power for movement and proper braking procedures. If this is not observed, the brake system may overheat and result in brake damage or brake fire.

4.4.4 BEFORE TAKE OFF

WARNING: Do not take off with frost, ice, snow, or other contamination on the fuselage, wing, stabilizers and/or control surfaces.

BEFORE TAKE OFF		
1	Doors	CHECK latched and secured
2	Seat Belts	CHECK FASTENED
3	Pitot Cover	CHECK removed
4	Flaps	+1
5	Trim	SET NEUTRAL
6	Power lever	CUT OFF
7	Parking brake	DISENGAGE
8	MASTER switch	CHECK ON
9	AVIONICS switch	CHECK ON
10	BATT EN switch	CHECK ON
11	PWR EN switches	CHECK ON
12	Transponder	SET
13	EPSI570C	CHECK TEMPERATURES
14	Altimeters	SET TO QNH OR QFE
15	Annunciator/warning panel - EPSI570C	CHECK no cautions/warnings



POWER CHECK		
1	Parking brake	CHECK ENGAGED
2	Power lever	FULL
3	Power (EPSI570C - flight page)	CHECK \geq 50 kW
4	Power lever	CUT OFF
5	EPSI570C - system page:	CHECK BATTERIES 'ACTIVE'
6	EPSI570C - Engine and battery temperatures	CHECK *
7	Annunciator/warning panel - EPSI570C	CHECK no cautions/warnings

CAUTION: At full power the motor RPM should be between 2200 and 2500, while the motor power should be 50 kW or more. If this is not the case, do not proceed with flight and check the system for correct installation.

* **CAUTION:** Max battery temperature is 45 °C at take off (see Limitations). Battery temperatures $>$ 40 °C at take off may result in high in-flight battery temperatures when OAT is high or high power settings are applied. See also Section 3 - Emergency procedures.

4.5 TAKE OFF

4.5.1 TAKE OFF RUN AND FLAP SETTINGS

For take off over a gravel or grass surface, advance power lever slowly. This allows the airplane to start rolling before high RPM is developed and gravel will be blown behind the propeller rather than pulled into it.

During the take off run, pull the stick gently to lift the nose wheel from the ground and set positive incidence. The aircraft will lift-off as speed increases.

Normal and short field take offs are accomplished with flaps set at (+1). Take offs using flaps (0) are permissible, however, no performance data is available for take offs in the flaps up configuration.

Soft or rough field take offs are performed with (+1) or (+2) flaps by lifting the airplane off the ground as soon as practical in a tail-low attitude. If no obstacles are ahead, the airplane can be accelerated immediately to a higher climb speed, while considering the flap limit airspeed.



Take offs into strong crosswinds are normally performed with the flaps set at (+1). Start the take off run with the control column deflected into the wind. Maintain direction with rudder, decreasing the aileron deflection as speed increases. Rotate at a speed slightly higher than normal. When clear of the ground, make a coordinated turn into the wind to correct for drift.

TAKE OFF		
1	Power lever	FULL
2	Power indication	CHECK \geq 50 kW
3	EPSI570C / annunciator	CHECK GREEN / NORMAL / no warnings or cautions
4	Airspeed	CHECK increasing
5	Rotate	SET slight positive pitch and lift off (50 KIAS)
6	Airspeed (initial climb)	57 - 60 KIAS
At safe altitude (300 ft AAL)		
7	Flaps	0
8	Power lever	REDUCE TO MCP
9	Airspeed	INCREASE TO 75 KIAS (V_r)

CAUTION: Add power gradually, as sudden bursts of power can cause air-frame damage on certain runways due to stones and debris.

WARNING: If, during the take off run, the motor PWR is less than 50 kW with power lever in full position, abort the take off immediately, come to a standstill and verify systems.



4.6 CLIMBING

Normal climbs are performed with flaps (0) and with power up to MCP (48 kW), with constant monitoring of propulsion system temperatures.

CAUTION: in case of prolonged MCP applications (i.e. unusual continuous climb from take off to ceiling altitude), batt temperature may reach the caution range, depending on OAT. Avoiding continuous climbs at MCP setting when flying at high OAT is advisable. Alternating climb legs with short cruise phases at lower power settings is recommended.

NOTE: V_x : 57 KIAS [flaps (0)], V_y : 75 KIAS [flaps (0)]

1	Climb Power	SET
2	Flaps	0
3	EPSI570C Parameters	CHECK/MONITOR

CAUTION: Prolonged use of higher power settings may increase engine system temperatures.

4.7 CRUISE

Normal cruising is performed with power setting between 20-36 KW.

1	Flaps	0
2	Cruise Power	SET
3	EPSI570C Parameters/SOC/RFT	CHECK/MONITOR

4.8 DESCENT/APPROACH

1	Altimeter	SET
2	EPSI570C Parameters/SOC/RFT	CHECK
3	Parking brake	CHECK DISENGAGED

NOTE: Due to the highly efficient design, descent rate in clean configuration and power lever idle may be lower than other airplanes of the same category. See Section 5 - Performance - for additional information.



4.9 LANDING

Abeam threshold		
1	Power lever	REDUCE TO CUT OFF
2	Flaps (below 81 kts)	+1
3	Airspeed	MAINTAIN 65 KIAS
Final		
4	Flaps (below 65 kts)	+2
5	Airspeed	MAINTAIN 60 KIAS

CAUTION: Landings should be made with full flaps. Glideslope should be controlled with power lever. Landings with less than full flaps are recommended in crosswinds, if the flaps fail to deploy or in order to extend the aircraft's glide distance due to motor malfunction.

NOTE: Due to the highly efficient design, descent rate in clean configuration and power lever idle may be lower than other airplanes of the same category. See Section 5 - Performance - for additional information.

Normal Landing

Normal landings are made with full flaps and with power on or off. Surface winds and air turbulence are usually the primary factors in determining the most comfortable approach speeds.

Actual touchdown should be made with power off and on the main wheels first to reduce the landing speed and subsequent need for braking. Gently lower the nose wheel to the runway after airplane speed has diminished. This is especially important for rough or soft field landings.

Short Field Landing

For a short field landing in smooth air conditions, make an approach at 60 KIAS with full flaps using enough power to control the glide path (slightly higher approach speeds should be used under turbulent air conditions). After all approach obstacles are cleared, progressively reduce power to reach idle just before touchdown and maintain the approach speed by lowering the nose of the airplane. Touchdown should be made with power-off and on the main wheels first. Immediately after touchdown, lower the nose wheel



and apply braking as required. For maximum brake effectiveness, retract the flaps, hold the control stick full back, and apply maximum brake pressure without skidding.

Crosswind Landing

Normal crosswind landings are made with (+1) flaps. Avoid prolonged slips. After touchdown, hold a straight course with rudder and brakes as required. The maximum allowable crosswind velocity is dependent upon pilot capability as well as aircraft limitations. Operation in direct crosswinds of 15 kts (7.5 m/s) has been demonstrated.

4.10 BALKED LANDING/GO AROUND

In a balked landing (go around), apply full power and climb at 59 KIAS, then after clearing any obstacles, retract the flaps, accelerate to the normal climb speed and repeat the pattern.

CAUTION: Go around maneuver should not be initiated if SOC is lower than 15%!

1	Power Lever	FULL
2	Airspeed	59 KIAS

After clear of obstacles:

4	Flaps	0
5	Airspeed	As required
6	EPSI570C Parameters/SOC/RFT	CHECK

NOTE: To minimize pilot's workload during the maneuver, it is advisable to reconfigure the aircraft from flaps (+2) directly to flaps (0) once safe altitude is reached.



4.11 AFTER LANDING

1	Power Lever	as required for taxi
2	Flaps	0

4.12 SHUT DOWN

1	Power lever	CUT OFF
2	ELT	CHECK not transmitting
3	PWR EN switch	OFF
4	BATT EN switch	OFF

NOTE: After a hard landing, the ELT may activate (flashing red light on ELT remote switch). To reset it, set the remote switch to ON first and then back to ARM/OFF position. Please check OEM documentation [2] for additional information.

4.13 PARKING

1	Parking brake	ENGAGED (if necessary)
2	Time	Noted
3	Hobbs time (EPSI system page)	Noted
4	AVIONICS switch	OFF
5	MASTER switch	OFF
6	BATT EN switch	CHECK OFF
7	PWR EN switch	CHECK OFF
8	Aircraft log book	Filled
9	Pitot cover	Apply
10	Wheel chocks	Apply



4.14 SOFT FIELD OPERATIONS

Soft fields are runways that have rough or soft surfaces, such as sand, snow, mud, or tall grass. Take off and landing procedures for soft field operations are described in 4.5.1. and 4.9.

4.15 STALL

The stall recovery procedure is standard and recovery can be performed by normal use of controls:

1	Control stick	Forward, to reduce angle of attack
2	Power lever	Add power
3	Horizontal flight	Resume

Stall recovery is performed with average pilot skills, with less than 20° of yaw or roll. The recovery maneuver generally requires less than 250 ft of altitude drop.

The aircraft is equipped with a haptic stall warning system in control stick handles that are activated as aerodynamic stall condition is imminent. An aural warning is emitted by the EPSI570C speaker and is also heard in the headsets.

Two stall types can be encountered when stalling the aircraft.

A-type stall: uncontrollable downward pitching motion (fully developed stall, usually accompanied by wing drop).

C-type stall: the control stick reaches the rear stop position.

Depending on a combination of several factors like aircraft mass, flaps setting, CG position, G-load, power setting and tempo of AOA increase/speed reduction, the stall can be A-type or C-type.



This page is intentionally left blank.



4.16

CHECKLISTS

NORMAL PROCEDURES

NOTE: Use of the following checklists is not obligatory
and at the discretion of the owner/operator.



This page is intentionally left blank.

PREFLIGHT WALK-AROUND

(Check POH for inspections to be carried out before the first flight of the day)

CABIN

Doors	UNLOCK/OPEN/ CLOSE/SECURE
ALL switches	CHECK OFF
Parking brake	ENGAGE
Wing spars and connectors	CHECK
Instrument panel, EPSI and all other instruments	CHECK condition, displays OK, EPSI USB cap present
Headphones/microphones	Connected
Required documents	ON BOARD
ELT switches (remote sw. and transmitter)	CHECK both switches in ARM/OFF position (armed)
Flight Controls and flap handle	CHECK free and correct
MASTER switch	ON
Batt overtemp warning lights - Annunciator - Haptic stall warning	CHECK SELFTEST
AVIONICS switch	ON
Circuit breakers	CHECK ENGAGED
Instruments	CHECK functional
Elevator trim	Centered
Power lever	CUT OFF
BAT EN switch	ON
PWR EN switch	ON
EPSI570C display / annunciator	Flight/System page ok, CHECK no warn/cautions

Continue →

CABIN (continue)

AUX BATT Voltage on EPSI570C	CHECK > 13V
Battery %SOC, SOH, temp, status "ACTIVE" (system page)	CHECK
Engine temperatures	CHECK
BAT EN switch	OFF
PWR EN switch	OFF
AVIONICS switch	OFF
MASTER switch	OFF

LEFT FUSELAGE

COM antenna (top)	Condition and attachment
Wing / fuselage seal	CHECK
XPDR antenna (underside)	Condition and attachment
Static pressure port	CHECK for blockage
Battery cooling system inlet and outlet	CHECK no obstructions
Rear battery compartment access panel	CHECK closed

LEFT MAIN LANDING GEAR

Landing gear	General condition
Tire	Condition, inflation, and wear
Wheel and brakes	Fluid leaks, evidence of overheating, general condition and wear
Chocks and tie down rings/ropes	Remove



LEFT WING	
Leading edge	CHECK condition
Tip	CHECK condition
Flaperon	Condition, attachment, movement
Flaperon gap seal	Condition, no wrinkles
Hinges, nuts	CHECK condition - Secured
EMPENNAGE	
Tie down rope	remove
Horizontal and vertical stabilizers	CHECK condition
Elevator and elevator U-piece	Condition and movement
Rudder	Condition and movement
Attachment bolts, hinges, nuts	CHECK condition - Secured
RIGHT FUSELAGE	
Static pressure port	Check for blockage
Wing / fuselage seal	CHECK
Door lock	CHECK Unlocked
Battery exhaust outlet	CHECK no thermal runaway
ELT antenna (top)	Condition and attachment



RIGHT WING

Flaperon	Condition, security and movement
Flaperon gap seal	Security, no wrinkles
Hinges, nuts	CHECK condition - Secured
Tip	CHECK condition
Leading edge	CHECK condition
Pitot tube	Cover removed, attachment, tube clear

RIGHT MAIN LANDING GEAR

Landing gear	General condition
Tire	Condition, inflation, and wear
Wheel and brakes	Fluid leaks, evidence of overheating, general condition and wear
Chocks and tie down rings/ropes	Remove

PROPELLER AND COWLINGS AREA

Cowlings	Attachment secured
Propeller	CHECK condition
Hub and blades	CHECK condition and blade pitch marker paint at blade roots
Spinner	CHECK condition
Propeller/spinner bolts and screws	CHECK
Air inlets, outlets	Unobstructed
Charging port door	Closed and latched



MOTOR and NOSE LANDING GEAR AREA	
Strut	CHECK condition
Nose landing gear	CHECK condition
Wheel and tire	CHECK condition
Shock absorber	CHECK/TEST
Front battery compartment access panels	CHECK closed
Battery exhaust outlet	CHECK no thermal runaway





STARTING MOTOR

BEFORE START-UP

MASTER switch	CHECK OFF
AVIONICS switch	CHECK OFF
BATT EN switch	CHECK OFF
PWR EN switch	CHECK OFF
Aircraft log book	FILLED
Doors	CHECK LATCHED AND SECURED
Position of rudder pedals	SET and LOCKED
Flight Controls	FULL, FREE AND CORRECT
Seat belts	ADJUSTED AND FASTENED
Power lever	CUT OFF
Parking brake	ENGAGE
Circuit breakers	CHECK ALL ENGAGED
ELT remote switch	CHECK "ARM/OFF" position (armed)

STARTING MOTOR - BEFORE Taxiing

MASTER switch	ON
Batt overtemp warning lights - Annunciator - Haptic stall warning	CHECK SELFTEST
AVIONICS switch	ON
Battery SOC on EPSI570C	CHECK $\geq 50\%$ and sufficient for the flight

Continue →

STARTING MOTOR - BEFORE Taxiing (continue)

Batteries SOH on EPSI570C	CHECK > 0%
AUX Batt voltage on EPSI570C	CHECK > 13V
Transponder	TURN ON AND SET CODE
○ EPSI570C - system page:	CHECK BATTERIES 'READY'
Power lever	CUT OFF
BATT EN switch	ON
PWR EN switch	ON
EPSI570C - system page:	CHECK BATTERIES 'ACTIVE'
Time	NOTED
Parking brake	DISENGAGE
Power lever	INCREASE FOR TAXI

POWER CHECK

○ Parking brake	CHECK ENGAGED
Power lever	FULL
Power (EPSI570C - flight page)	CHECK \geq 50 kW
Power lever	CUT OFF
EPSI570C - system page:	CHECK BATTERIES 'ACTIVE'
EPSI570C - Engine and battery temperatures	CHECK
Annunciator/warning panel - EPSI570C	CHECK no cautions/ warnings

BEFORE TAKE OFF

Doors	CHECK latched and secured
Seat Belts	CHECK FASTENED
Pitot cover	CHECK removed
Flaps	+1
Trim	SET NEUTRAL
Power lever	CUT OFF
Parking brake	DISENGAGE
MASTER switch	CHECK ON
AVIONICS switch	CHECK ON
BATT EN switch	CHECK ON
PWR EN switches	CHECK ON
Transponder	SET
EPSI570C	CHECK TEMPERATURES
Altimeter	SET TO QNH OR QFE
Annunciator/warning panel - EPSI570C	CHECK no cautions/ warnings

TAKE OFF

TAKE OFF

Power lever	FULL
Power indication	CHECK \geq 50 kW
EPSI570C / annunciator	CHECK GREEN / NORMAL / no warnings or cautions
Airspeed	CHECK increasing
Rotate	SET slight positive pitch and lift off (50 KIAS)
Airspeed (initial climb)	57-60 KIAS
At safe altitude (300 ft AAL)	
Flaps	0
Power lever	REDUCE TO MCP (48 kW)
Airspeed	INCREASE TO 75 KIAS (Vy)

CLIMBING

Climb Power	Set
Flaps	0
EPSI570C Parameters	CHECK/MONITOR

CRUISE

Flaps	0
Cruise Power	SET (20-36 kW)
EPSI570C Parameters/ SOC/RFT	CHECK/MONITOR

DESCENT / APPROACH

Altimeter	SET
EPSI570C Parameters/ SOC/RFT	CHECK
Parking brake	CHECK DISENGAGED

LANDING

Abeam threshold

Power lever	REDUCE TO CUT OFF
Flaps (below 81 kts)	+1
Airspeed	MAINTAIN 65 KIAS

Final

Flaps (below 65 kts)	+2
Airspeed	MAINTAIN 60 KIAS

BALKED LANDING / GO AROUND

Power Lever	FULL
Airspeed	59 KIAS

After clear of obstacles:

Flaps	0
Airspeed	As required
EPSI570C Parameters/ SOC/RFT	CHECK

STALL

Control stick	Forward, to reduce AOA
Power lever	Add power
Horizontal flight	Resume

AFTER LANDING

Power Lever	as required for taxi
Flaps	0

SHUT DOWN

Power lever	CUT OFF
ELT	CHECK not transmitting
PWR EN switch	OFF
BATT EN switch	OFF

PARKING

Parking brake	ENGAGED (if necessary)
Time	Noted
Hobbs time (EPSI system page)	Noted
AVIONICS switch	OFF
MASTER switch	OFF
BATT EN switch	CHECK OFF
PWR EN switch	CHECK OFF
Aircraft log book	Filled
Pitot cover	Apply
Wheel chocks	Apply



This page is intentionally left blank.

SECTION

5



SECTION 5 – PERFORMANCE DATA

TABLE OF CONTENTS

PART	SUBJECT	PAGE NUMBER
5.1	INTRODUCTION	5-3
5.2	OUTSIDE AIR TEMPERATURE FOR ISA-CONDITION	5-4
5.3	WIND COMPONENT	5-5
5.4	AIRSPED CALIBRATION	5-6
5.5	STALL SPEED	5-8
5.6	TAKE OFF DISTANCE	5-9
5.7	CLIMB PERFORMANCE	5-11
	Rate of Climb Climb Gradient	
5.8	CRUISE PERFORMANCE	5-12
5.9	ENDURANCE AND RANGE	5-13
	Local Flight (A-A Flight) Cruise Flight (A-B Flight)	
5.10	LANDING DISTANCE	5-17
5.11	ENERGY CONSUMPTION	5-19
5.12	MISSION PLANNING - EXAMPLES	5-21
5.13	NOISE CHARACTERISTICS	5-26

APPROVED

PAGE
5-2

PIPISTREL

POH-128-00-40-001
PAGE REV. 0



5.1 INTRODUCTION

The performance tables and diagrams on the following pages show the performance of the airplane. The data presented in these tables and diagrams has been derived from test-flights using an airplane, motor and batteries in good operating condition, and was corrected to standard atmospheric conditions 15° C and 1013.25 mb at sea level.

The performance tables do not take into account the expertise of the pilot or the maintenance condition of the airplane. The performance illustrated in the tables can be achieved if the indicated normal procedures are followed and the airplane is maintained properly.

The energy consumption during cruise is based on propeller RPM and power settings. Some undefined variables such as the batteries state of health, contamination of the aircrafts surface, or turbulence could influence flight distance and flight duration. For this reason, it is of utmost importance that all available data is used when calculating the range and endurance.



5.2 OUTSIDE AIR TEMPERATURE FOR ISA-CONDITION

Pressure Altitude [ft]	ISA -15°C	ISA -5°C	ISA	ISA +5°C	ISA +15°C
SL	0	10	15	20	30
1000	-2	8	13	18	28
2000	-4	6	11	16	26
3000	-6	4	9	14	24
4000	-8	2	7	12	22
5000	-10	0	5	10	20
6000	-12	-2	3	8	18
7000	-14	-4	1	6	16
8000	-16	-6	-1	4	14
9000	-18	-8	-3	2	12
10000	-20	-10	-5	0	10
11000	-22	-12	-7	-2	8
12000	-24	-14	-9	-4	6
13000	-26	-16	-11	-6	4
14000	-28	-18	-13	-8	2



5.3 WIND COMPONENT

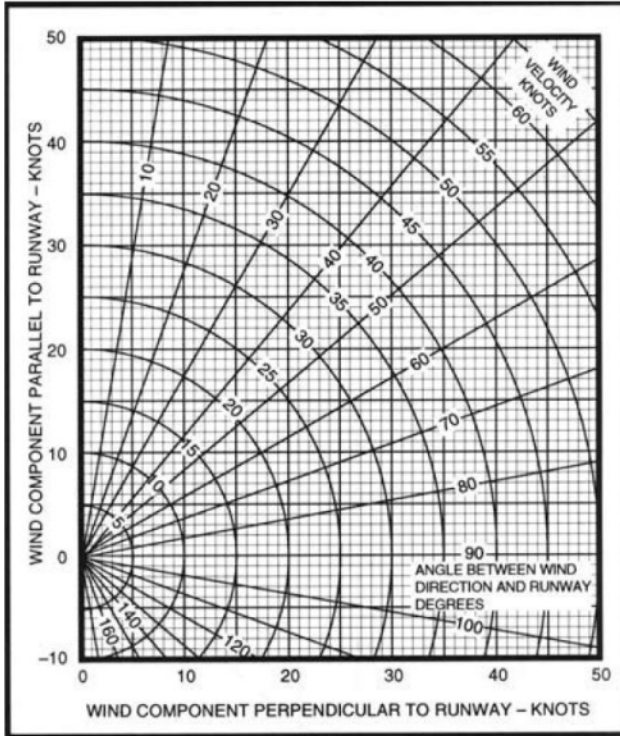

EXAMPLE:

Runway Heading:	10°
Wind Direction:	60°
Angle between wind and runway:	50°
Wind Velocity:	15 Knots
Component parallel:	~9,6 Knots
Component perpendicular:	~11,5 Knots



5.4 AIRSPEED CALIBRATION

Conditions

Power: power level for level flight, or idle when indicated.

NOTE: Indicated airspeed values assume zero instrument error.

KIAS	KCAS			
	Flaps (0) level flight	Flaps (+1) level flight	Flaps (+2) level flight	Flaps (+2) idle
50	---	50	50	49
55	53	55	56	55
60	58	61	61	60
65	63	66	66	66
70	68	72	---	---
75	74	77	---	---
80	79	82	---	---
85	84	---	---	---
90	89	---	---	---
95	95	---	---	---
100	100	---	---	---
105	105	---	---	---
108	108	---	---	---



KIAS/KCAS Diagram

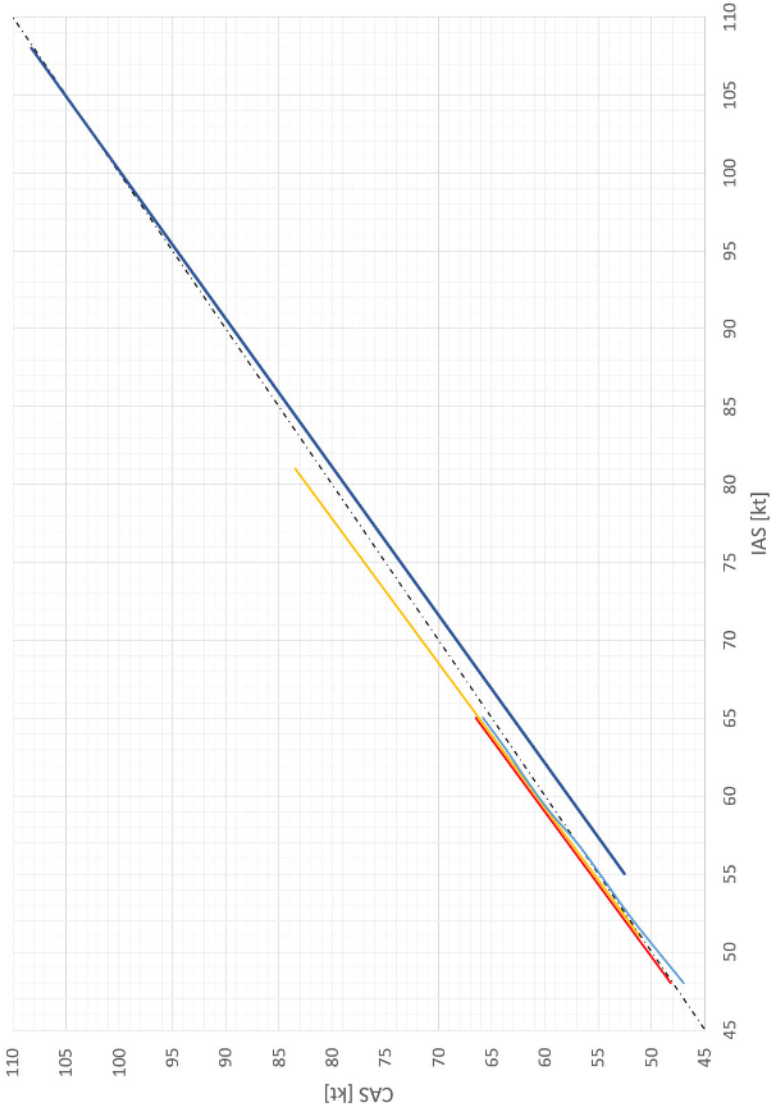
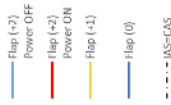



5.5 STALL SPEED

Conditions

Power: MTOM

NOTE: The recovery altitude necessary is very dependent on the tempo of recovery.

Typical loss of altitude for recovery:	
Slow recovery without power:	150-250 ft
Normal recovery with power:	100 ft
Aggressive recovery	less than 100 ft

Depending on pilot skill, the altitude loss during wing level stall may be 250 feet or more.

NOTE: KIAS values may not be accurate at stall.

WEIGHT - POWER	BANK ANGLE	STALL SPEED					
		Flaps (+0)		Flaps (+1)		Flaps (+2)	
kg	Degrees	KIAS	KCAS	KIAS	KCAS	KIAS	KCAS
600 POWER OFF	0°	53	51	46	46	46	45
600 POWER ON	0°	50	48	44	43	43	42

NOTE: The aircraft is equipped with an aural and haptic stall warning system installed in the control stick handles.



5.6 TAKE OFF DISTANCE

Conditions	Power:	MPTOP (50kW)
	Flaps:	(+1)
	Wind:	Calm
	Mass:	600 kg
	Runway condition:	dry
	Speed at lift off:	50 KIAS
	Speed over the obstacle:	57 KIAS (V_x)

Take off performance data included in this POH are extrapolated from flight test results. These extrapolated values serve as an estimation of actual take off roll and total distance to clear a 50 ft obstacle (ground roll plus climb distance to clear obstacle).

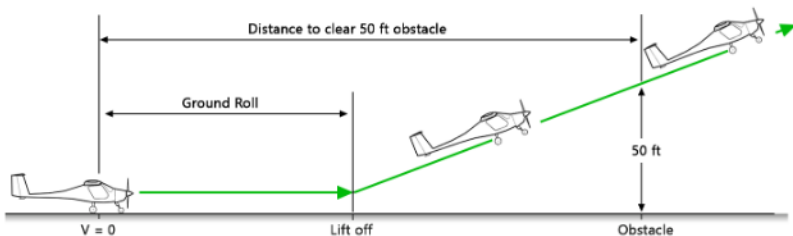

Correction Factors

Headwind:	Subtract 10% for each 12 knots headwind.
Tailwind:	Add 10% for each 2 knots tailwind up to 10 knots.
Wet Grass:	Add 18% to ground roll on dry grass.

Runway Slope

Increase table distances by 22% of the ground roll distance at sea level for each 1% of upslope.

Decrease table distances by 7% of the ground roll distance at sea level, for each 1% of downslope.



PRESSURE Altitude [ft]	DISTANCE [m]	Runway Surface	TEMPERATURE				
			ISA -15°C	ISA -5°C	ISA	ISA +5°C	ISA +15°C
SL	Ground roll	Asphalt	208	230	240	250	268
	50 ft obst.		391	430	448	466	499
	Ground roll	Grass	236	260	272	283	304
	50 ft obst.		476	507	517	526	555

PRESSURE Altitude [ft]	DISTANCE [m]	Runway Surface	TEMPERATURE				
			ISA -15°C	ISA -5°C	ISA	ISA +5°C	ISA +15°C
4000	Ground roll	Asphalt	276	295	304	313	330
	50 ft obst.		512	547	564	580	610
	Ground roll	Grass	312	335	345	355	375
	50 ft obst.		591	631	650	669	704

PRESSURE Altitude [ft]	DISTANCE [m]	Runway Surface	TEMPERATURE				
			ISA -15°C	ISA -5°C	ISA	ISA +5°C	ISA +15°C
8000	Ground roll	Asphalt	337	355	363	371	387
	50 ft obst.		622	654	669	684	712
	Ground roll	Grass	382	402	412	421	438
	50 ft obst.		731	768	785	802	833

PRESSURE Altitude [ft]	DISTANCE [m]	Runway Surface	TEMPERATURE				
			ISA -15°C	ISA -5°C	ISA	ISA +5°C	ISA +15°C
12000	Ground roll	Asphalt	393	409	417	424	438
	50 ft obst.		772	751	765	778	804
	Ground roll	Grass	445	464	472	481	497
	50 ft obst.		833	867	883	898	927

CAUTION: MTOP must be limited to 90 seconds (see Limitations - Section 2).



5.7 CLIMB PERFORMANCE

Conditions Power setting: MCP 48 kW or max continuous RPM 2300, whatever is reached first

Flaps: (0)

CAUTION: when battery temperatures are above 40 °C, prolonged high-power application (circuit patterns or prolonged climbs at MCP) may lead to battery high temperature.

CAUTION: in case of prolonged MCP applications (i.e. unusual continuous climb from take off to ceiling altitude), battery temperature may reach the caution range, depending on OAT. Avoiding continuous climbs at MCP setting when flying at high OAT is advisable. Alternating climb legs with short cruise phases at lower power settings is recommended.

5.7.1 RATE OF CLIMB ($V_y = 75$ KIAS)

MASS/ AIR SPEED	Pressure Altitude (PA)	RATE OF CLIMB [ft/min]				
	ft	ISA -15°C	ISA -5°C	ISA	ISA +5°C	ISA +15°C
V_y 75 KIAS	0	683	658	647	636	615
	4000	602	580	570	560	541
	8000	439	423	415	408	393
	12000	276	265	260	255	246

NOTE: Electric motor power output is constant with altitude, but power is gradually reduced with altitude by the pilot to respect max RPM limit (2300).

5.7.2 CLIMB GRADIENT ($V_x = 57$ KIAS)

MASS/ AIR SPEED	Pressure Altitude (PA)	CLIMB ANGLE / GRADIENT
	ft	
V_x 57 KIAS	0	6.1 / 10.7
	4000	4.5 / 7.9
	8000	3.1 / 5.4
	12000	2 / 3.4

CAUTION: Expect the climb performance to degrade with increased outside air temperature.



5.8 CRUISE PERFORMANCE

Conditions	Mass:	600 kg
	Flaps:	(0)
	Altitude:	Sea Level - ISA

The table presents cruise speeds at different power settings between minimum power for level flight (20 kW) and maximum continuous RPM power (36 kW).

POWER SETTING (EPSI)	RPM	KIAS	KCAS
[kW]	[1/min]	[kts]	[kts]
20	1780	71	69
25	1950	79	78
30	2120	87	86
35	2270	92	92
36	2300	93	93

NOTE: 36 kW power setting corresponds to 2300 RPM, max continuous RPM. The airspeed at this power setting is considered maximum cruise speed (93 KIAS).

$V_H = 93$ KIAS (=93 KCAS) @2300 RPM

NOTE: Expect a 2% CAS decrease every 1000 ft of altitude increase, at the same RPM setting.



5.9 ENDURANCE AND RANGE

CAUTION: The available battery energy is a function of SOC and SOH. Both parameters must be considered for a correct endurance estimation. Reduction of SOH (usually due to aging/use) reduces the batteries' energy storage capability and, therefore, also endurance.

CAUTION: Always consider that battery temperature $>40^{\circ}\text{C}$ at take off may affect the duration of flight, as the mission must be aborted when the in-flight battery temperature exceeds the caution threshold (50°C).

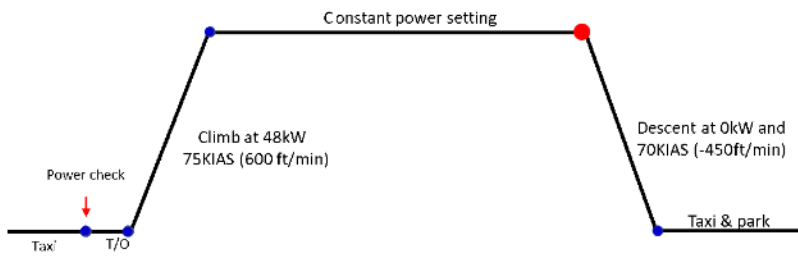

Endurance and range
typical flight profile

The following tables present expected endurance for local flights (A-A flight) and endurance/range for cross country flights (A-B flight). VFR reserve is different for the two situations, 10 min or 30 min, in accordance with Ops.125.



5.9.1 LOCAL FLIGHT (A-A FLIGHT)

A local flight is defined as a flight starting from and landing at the same airfield (A to A flight). Typical flight profile is illustrated in Section 5.9.

NOTE: in the following table initial SOC is 100%. The energy used to climb to cruise altitude and for descent is already included in the calculation.

A-A FLIGHT ENDURANCE in minutes (+ 10 min reserve @20 kW)							
Cruise altitude [ft]	Cruise power [kW]	Battery State of Health - SOH [%]					
		100	80	60	40	20	0
1500	20	52 min	45 min	39 min	32 min	25 min	18 min
	25	42 min	37 min	32 min	26 min	21 min	15 min
	30	36 min	32 min	27 min	23 min	18 min	14 min
	35	31 min	28 min	24 min	20 min	16 min	13 min
2000	20	52 min	45 min	38 min	31 min	25 min	18 min
	25	43 min	37 min	32 min	26 min	21 min	16 min
	30	36 min	32 min	28 min	23 min	19 min	14 min
	35	32 min	28 min	25 min	21 min	17 min	13 min
4000	20	51 min	44 min	37 min	30 min	24 min	17 min
	25	44 min	38 min	33 min	27 min	22 min	16 min
	30	39 min	34 min	30 min	25 min	21 min	16 min
	35	35 min	31 min	28 min	24 min	20 min	16 min
6000	20	50 min	43 min	36 min	29 min	-	-
	25	45 min	39 min	34 min	28 min	-	-
	30	41 min	36 min	32 min	27 min	-	-
	35	38 min	34 min	31 min	27 min	-	-

CAUTION: the endurance values in the table above do not include the additional 10 min reserve at 20 kW. After using reserve, SOC = 0%.



5.9.2 CRUISE FLIGHT (A-B FLIGHT)

A cruise/cross-country flight is defined as a flight starting from airfield A and landing at a different airfield (A to B flight). Typical flight profile is illustrated in Section 5.9.

NOTE: in the following tables initial SOC is 100%. The energy used to climb to cruise altitude and for descent is already included in the calculation.

A-B FLIGHT ENDURANCE in minutes (+ 30 min reserve @20 kW)							
Cruise altitude [ft]	Cruise power [kW]	Battery State of Health - SOH [%]					
		100	80	60	40	20	0
1500	20	32 min	25 min	19 min	12 min	-	-
	25	27 min	21 min	16 min	10 min	-	-
	30	23 min	19 min	14 min	10 min	-	-
	35	20 min	17 min	13 min	9 min	-	-
2000	20	32 min	25 min	18 min	11 min	-	-
	25	27 min	22 min	16 min	11 min	-	-
	30	24 min	19 min	15 min	10 min	-	-
	35	21 min	17 min	14 min	10 min	-	-
4000	20	31 min	24 min	17 min	-	-	-
	25	28 min	23 min	17 min	-	-	-
	30	26 min	21 min	17 min	-	-	-
	35	24 min	20 min	17 min	-	-	-
6000	20	30 min	-	-	-	-	-
	25	29 min	-	-	-	-	-
	30	28 min	-	-	-	-	-
	35	27 min	-	-	-	-	-

CAUTION: the endurance values in the table above do not include the additional 30 min reserve at 20 kW. After using reserve, SOC = 0%.



A-B FLIGHT RANGE in km (+ 30 min reserve @20 kW / 64 km) WIND = 0							
Cruise altitude [ft]	Cruise power [kW]	SOH [%]					
		100	80	60	40	20	0
1500	20	68 km	53 km	38 km	23 km	-	-
	25	62 km	49 km	35 km	22 km	-	-
	30	57 km	45 km	33 km	21 km	-	-
	35	52 km	42 km	31 km	20 km	-	-
2000	20	68 km	53 km	38 km	22 km	-	-
	25	62 km	49 km	35 km	22 km	-	-
	30	57 km	45 km	33 km	21 km	-	-
	35	53 km	42 km	31 km	20 km	-	-
4000	20	65 km	50 km	34 km	-	-	-
	25	62 km	48 km	34 km	-	-	-
	30	59 km	46 km	34 km	-	-	-
	35	56 km	45 km	33 km	-	-	-
6000	20	62 km	-	-	-	-	-
	25	61 km	-	-	-	-	-
	30	59 km	-	-	-	-	-
	35	58 km	-	-	-	-	-

CAUTION: the range values in the table above do not include the additional 30 min reserve at 20 kW. After using reserve, SOC = 0%.

CAUTION: the table above is valid when wind is 0.

Example: A-B flight, battery SOH = 60%, expected range and endurance for a 4000 ft cruise flight @30 kW power setting are: 34 km range and 17 min endurance, with 30 minutes of reserve (in accordance with Ops.125).



5.10 LANDING DISTANCE

Conditions	Wind:	zero
	Runway:	dry and leveled
	Flaps:	(+2)
	Power:	CUT OFF
	Airspeed:	60 KIAS at 50 ft height
	Mass:	600 kg
	Brakes:	applied 1s after touch down

The landing performance data included in this POH are extrapolated from flight test results. These extrapolated values serve as an estimation of actual landing roll and total landing distance after clearing 50 ft obstacle (ground roll included).

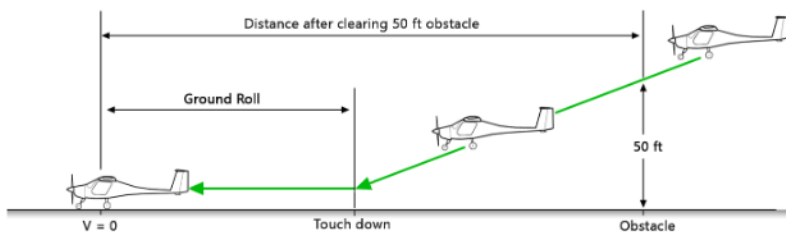

Correction Factors

Headwind:	Subtract 10% from table distances for each 13 knots of headwind.
Tailwind:	Add 10% to table distances for each 2 knots of tailwind up to 10 knots.

Wet grass runway: Add 30% to ground roll distance for dry grass runway.

Sloped Runway

Increase table distances by 27% of the ground roll distance for each 1% of downslope.

Decrease table distances by 9% of the ground roll distance for each 1% of upslope.

CAUTION: The corrections should be used with caution since published runway slope data is usually the net slope from one end of the runway to the other. Many runways will have portions of their length at greater or lesser



SECTION 5

PERFORMANCE DATA

slopes than the published slope, affecting the estimation of landing ground roll.

For operation in outside air temperatures colder than what's displayed in the following tables, use coldest data shown.

PRESSURE Altitude [ft]	DISTANCE [m]	Runway Surface	TEMPERATURE				
			ISA -15°C	ISA -5°C	ISA	ISA +5°C	ISA +15°C
SL	Ground roll	Asphalt	170	180	183	186	196
	50 ft obst.		516	526	537	553	569
	Ground roll	Grass	180	190	193	196	207
	50 ft obst.		552	564	575	592	610

PRESSURE Altitude [ft]	DISTANCE [m]	Runway Surface	TEMPERATURE				
			ISA -15°C	ISA -5°C	ISA	ISA +5°C	ISA +15°C
4000	Ground roll	Asphalt	182	199	206	213	232
	50 ft obst.		557	568	580	597	615
	Ground roll	Grass	192	210	217	225	245
	50 ft obst.		596	609	621	640	658

PRESSURE Altitude [ft]	DISTANCE [m]	Runway Surface	TEMPERATURE				
			ISA -15°C	ISA -5°C	ISA	ISA +5°C	ISA +15°C
8000	Ground roll	Asphalt	205	225	233	241	263
	50 ft obst.		598	610	623	642	660
	Ground roll	Grass	216	237	246	254	277
	50 ft obst.		640	654	667	687	707

PRESSURE Altitude [ft]	DISTANCE [m]	Runway Surface	TEMPERATURE				
			ISA -15°C	ISA -5°C	ISA	ISA +5°C	ISA +15°C
12000	Ground roll	Asphalt	232	255	264	274	299
	50 ft obst.		639	653	666	686	706
	Ground roll	Grass	245	268	278	289	315
	50 ft obst.		684	699	713	734	756

APPROVED



5.11 ENERGY CONSUMPTION

The following tables can be used for the estimation of energy consumption (%SOC) in different flight phases and typical mission scenarios. SOH of the battery must be taken into account because it affects the amount of energy (%SOC) used in each flight phase.

CAUTION: Always consider that battery temperature $>40^{\circ}\text{C}$ at take off may affect the duration of flight, as the mission must be aborted when the in-flight battery temperature exceeds the caution threshold (50°C). Battery temperature $> 40^{\circ}\text{C}$ at take off may result in high in-flight battery temperatures when OAT is high or high power settings are applied.

NOTE: Flight phases are to be executed according to the procedures and parameters described in Section 4 - Normal procedures.

A typical flight can be made of several circuit patterns or can be a training sortie composed by different flight phases and cruise.

Circuit patterns with one charge

The following table provides information about maximum number of circuit patterns that can be performed starting with 100% SOC.

LOCAL FLIGHT with 100% SOC at take off	Battery State of Health (%SOH)					
	100	80	60	40	20	0
NUMBER OF TRAFFIC PATTERNS:	8	7	6	5	4	3
RESERVE:	+ 10 minutes (@ 20 kW power setting)					

NOTE: reference circuit pattern is a 12 km circuit at 1000 ft AGL.



Training sortie

The following table provides information about percentage of SOC needed for each flight phase.

FLIGHT PHASE		Battery State of Health (%SOH)					
		100	80	60	40	20	0
Take off and initial climb to 300 ft AGL	%SOC	4	4	5	6	7	8
1000 ft climb at V_y - 48 kW	%SOC	7	7	8	10	12	14
10 min cruise - 20 kW (69 KCAS)	%SOC	15	17	19	22	26	32
10 min cruise - 25 kW (78 KCAS)	%SOC	19	22	25	28	34	41
10 min cruise - 30 kW (86 KCAS)	%SOC	24	26	30	35	41	50
10 min cruise - 35 kW (92 KCAS)	%SOC	28	31	36	41	49	59
Touch and go and climb to 300 ft AGL	%SOC	3	3	4	4	5	6
Energy for the first traffic pattern	%SOC	10	11	13	15	18	22
Energy for a generic traffic pattern	%SOC	9	10	12	13	16	20
Aborted landing and climb to 1000 ft AGL at V_y - 64 kW	%SOC	7	8	9	10	12	15



5.12 MISSION PLANNING - EXAMPLES

Following examples show typical mission profiles and scenarios. Parameters for calculation are taken from tables in current Section 5 - Performance Data.

A) POINT OF NO RETURN (PNR) - CALCULATION EXAMPLE:

When flying the VELIS Electro outside the circuit pattern, it is important to estimate when the remaining energy is sufficient for a safe return to home base. The PNR (Point of No Return) in flight is when there is just sufficient SOC to return to base (and arrive there with 30%). This PNR is calculated for flights from point A to point A (A-A Flight). Most VELIS Electro flights are A-A.

NO WIND CONDITION - CALCULATION EXAMPLE

When flying in no wind conditions along a straight track, calculating PNR is not particularly difficult. There is enough SOC available to take off and fly toward the destination knowing, that as long as the flight does not proceed beyond the halfway point, it should be possible to make it back to home airfield safely.

If the take off is with 100% SOC, landing must be planned at minimum 30% SOC. Therefore total usable SOC is 70%. If (example) 10% of the SOC is used for the climb to cruise altitude, the remaining 60% is available for the cruise. Half of SOC available for cruising is 30%. So the turning back to the initial cruise point occurs after using 10% SOC for climbing and 30% of SOC available for cruise: PNR results at 60% of SOC ($100\% - 10\% - 30\% = 60\%$). The example assumes that cruise initial/final points are in proximity of the airport. "PNR REFERENCE TABLES" provided in this section can be used for easy calculation of PNR.

WINDY CONDITION - CALCULATION EXAMPLE

Cruise speed 85 kts (example), and outbound tailwind of 15 kts (from GPS ground speed reading). The difference between the IAS and TAS at VELIS Electro altitudes are negligible and is possible to consider IAS = TAS.

Therefore:

GS outbound: $85 \text{ kts} + 15 \text{ kts (tailwind)} = 100 \text{ kts}$

GS inbound: $85 \text{ kts} - 15 \text{ kts (headwind)} = 70 \text{ kts}$

The %SOC to PNR is calculated with the PNR equation:



PNR SOC = usable SOC x GS homebound / (GS homebound + GS outbound).
In this example: $70\% \times 70 \text{ kts} / (100 \text{ kt} + 70 \text{ kts}) = 28\%$, that is the SOC used to reach PNR. So, in this example, PNR is $100\% - 28\% = 72\%$, where 100% is the initial SOC.

This is very important. When flying with a tailwind it is necessary to turn back to the point of origin much sooner.

PNR REFERENCE TABLES

The following tables provide quick reference for PNR calculation, depending on cruise power/speed and wind. PNR SOC is the SOC value at which the return to the initial cruise point is possible, with 30% SOC remaining.

20 kW		Tailwind outbound, headwind inbound (kts)				No wind	Headwind outbound, tailwind inbound (kts)			
69 KCAS		-20	-15	-10	-5	0	5	10	15	20
INITIAL SOC:	90	69	67	64	62	60	58	56	53	51
	80	62	60	59	57	55	53	51	50	48
	70	56	54	53	51	50	49	47	46	44
	60	49	48	47	46	45	44	43	42	41

25 kW		Tailwind outbound, headwind inbound (kts)				No wind	Headwind outbound, tailwind inbound (kts)			
78 KCAS		-20	-15	-10	-5	0	5	10	15	20
INITIAL SOC:	90	68	66	64	62	60	58	56	54	52
	80	61	60	58	57	55	53	52	50	49
	70	55	54	53	51	50	49	47	46	45
	60	49	48	47	46	45	44	43	42	41



30 kW		Tailwind outbound, headwind inbound (kts)				No wind	Headwind outbound, tailwind inbound (kts)			
86 KCAS		-20	-15	-10	-5	0	5	10	15	20
INITIAL SOC:	90	67	65	63	62	60	58	57	55	53
	80	61	59	58	56	55	54	52	51	49
	70	55	53	52	51	50	49	48	47	45
	60	48	48	47	46	45	44	43	42	42

35 kW		Tailwind outbound, headwind inbound (kts)				No wind	Headwind outbound, tailwind inbound (kts)			
92 KCAS		-20	-15	-10	-5	0	5	10	15	20
INITIAL SOC:	90	67	65	63	62	60	58	57	55	53
	80	60	59	58	56	55	54	52	51	50
	70	54	53	52	51	50	49	48	47	46
	60	48	47	47	46	45	44	43	43	42

Example:

Cruise flight @ 25 kW power setting (corresponding to 78 KCAS).

SOC at the beginning of the cruise phase = 80% SOC.

Wind: 10 kts headwind outbound (same amount inbound)

The SOC at which the return has to be initiated to be back at the initial point with 30% remaining SOC is PNR SOC = 52%.



B) A-B FLIGHT - MISSION PLANNING - CALCULATION EXAMPLE:

NOTE: all the values will be used purely as example

To compute the SOC needed for the mission, it is necessary to know:

- Battery SOH and SOC (system page of EPSI570C)
- The flight profile of the mission (phases)

The total SOC is computed by adding the SOC consumed in each phase.

CAUTION: Always consider that battery temperature $>40\text{ }^{\circ}\text{C}$ at take off may affect the duration of flight, as the mission must be aborted when the in-flight battery temperature exceeds the caution threshold ($50\text{ }^{\circ}\text{C}$).

1) Determination of initial battery conditions (check EPSI570C)

The following are the values that will be used in the example:

- SOH = 80%.
- SOC = 95%.

Battery SOH = 80% determines the use of SECOND COLUMN ("80") from the tables presented in Section 5.11 - Energy Consumption.

2) Determination of mission profile and flight phases

Define the mission profile and divide it into phases. Example:

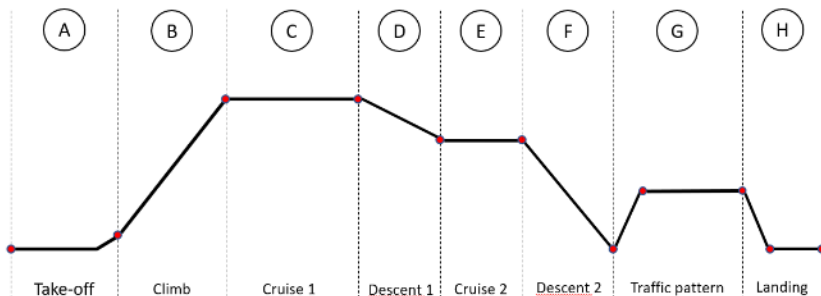



The mission profile is divided in the following phases:

- A) Take off
- B) Climb (V_{γ}) at 48 kW - to 2000 ft AGL
- C) Cruise 1 at 25 kW - for 5 min
- D) Descent 1 - to 1000 ft AGL
- E) Cruise 2 at 20 kW - for 10 min
- F) Descent 2 - to airfield level
- G) Generic traffic pattern - 1000 ft
- H) Landing - to full stop

3) Calculation of energy (%SOC) used for each phase, using previous tables: all values are obtained from column SOH = 80%

- A) Take off = 4 %SOC
- B) Climb (V_{γ}) at 48 kW - to 2000 ft AGL = $2 \times 7 \text{ %SOC} = \underline{14 \text{ %SOC}}$
- C) Cruise 1 at 25 kW - for 5 min = $0.5 \times 21 \text{ %SOC} = \underline{11 \text{ %SOC}}$
- D) Descent 1 - to 1000 ft AGL = 0 %SOC
- E) Cruise 2 at 20 kW - for 10 min = 17 %SOC
- F) Descent 2 - to airfield level = 0 %SOC
- G) Generic traffic pattern - 1000 ft = 10 %SOC
- H) Landing - to full stop = 0 %SOC

4) Total %SOC necessary for the mission is the sum of %SOC used for each phase of the flight (use of a similar table is recommended):

Flight phase	Target/conditions	SOC required (SOH 80%)
A) Take off	-	4
B) Climb (V_{γ}) - at 48 kW	to 2000 ft	14



SECTION 5

PERFORMANCE DATA

C) Cruise 1 - at 25 kW	5 min	11
D) Descent 1 - 0 kW	to 1000 ft	0
E) Cruise 2 - at 20 kW	10 min	17
F) Descent 2 - 0 kW	to airfield level	0
G) Generic traffic pattern	1000 ft	10
H) Landing	to full stop	0
TOTAL SOC:		56

5) Calculation of %SOC at landing:

%SOC at landing = Initial %SOC - mission %SOC = 95 - 56 = 39 %SOC

This value is > 30%SOC

Initial %SOC is sufficient for the mission, and remaining %SOC at landing (39%) is above the minimum prescribed in "limitations" (min SOC at landing 30%).

The mission can be safely flown.

5.13 NOISE CHARACTERISTICS

Noise level according to ICAO Annex 16, Chapter 10:

Measured: 60.1 dB(A) Max. allow. noise level: 70.8 dB(A)

SECTION

6



SECTION 6 – WEIGHT AND BALANCE

TABLE OF CONTENTS

PART	SUBJECT	PAGE NUMBER
6.1	INTRODUCTION	6-3
6.2	C.G. - CALCULATION SAMPLE	6-4
6.3	WEIGHT AND BALANCE CHART	6-5

APPROVED

PAGE
6-2

PIPISTREL

POH-128-00-40-001
PAGE REV. 0



6.1 INTRODUCTION

This section provides information about how to calculate the take off weight and C.G. of the aircraft. Once calculated, these two values can be used to find a point on the weight and balance chart (see section 6.3) and thus determine whether aircraft is within the flight limits (see section 2.6). A sample calculation is provided for reference.

WARNING: It is the owner and/or operator's responsibility to ensure the aircraft's take off weight and C.G. are within the envelope presented in the weight and balance chart (see section 6.3).

NOTE: The aircraft's empty weight and empty weight C.G. are the starting point for all take off calculations. Please refer to the aircraft's weight and balance report [1] for the current empty weight data.

**6.2 C.G. - CALCULATION- SAMPLE**

The calculation below is an example of how to calculate the aircraft's take off weight and C.G.. Except for the arm values in *italic* font, the values do not apply to any particular aircraft and are for illustration purposes only. The arm values in *italic* font are accurate and shall be used for any preflight calculations. The calculation results (i.e. Total weight and C.G.) shall be entered into the weight and balance chart in section 6.4, to determine whether the aircraft is within the flight limits prescribed in section 2.6.

NOTE: Calculate the moment for each item by multiplying its weight by its arm. Add up the moments to get the total moment and then divide by the total weight to get the C.G.

	WEIGHT [kg]	ARM [mm]	MOMENT [kgmm]
Aircraft empty weight	420*	270*	113400
Pilot	70	<i>370</i>	25900
Co-pilot	75	<i>370</i>	27750
Total weight / Moment	565	-	167050
Center of Gravity	-	296	-

*Example value. The actual values are to be obtained from the applicable aircraft's weight and balance report [1].

Max. take off weight: 600 kg

Most forward CG (with crew): 269 mm / 25.2 % MAC

Most rearward CG (with crew): 336 mm / 32.6 % MAC

NOTE: distances in mm are measured from datum, leading edge at wing root.

Example Center of Gravity at 296 mm is 28.2 % MAC, which is within the given range. CG expressed as %MAC can be calculated using the following:

$$CG_{\%MAC} = 100 \times \frac{CG_{(mm)} - 43}{897} = 100 \times \frac{296 - 43}{897} = 28.2 \%MAC$$

To perform and log weight and balance please use VELIS Electro Weight & Balance Report [1].



6.3 WEIGHT AND BALANCE CHART

The chart below shows the VELIS Electro mass-CG envelope. Once the aircraft's take off weight and C.G. have been calculated, they can be used to find a point in the chart and determine whether or not the aircraft is within the flight limits. Points A and B in the chart are taken from the sample calculation in section 6.2.

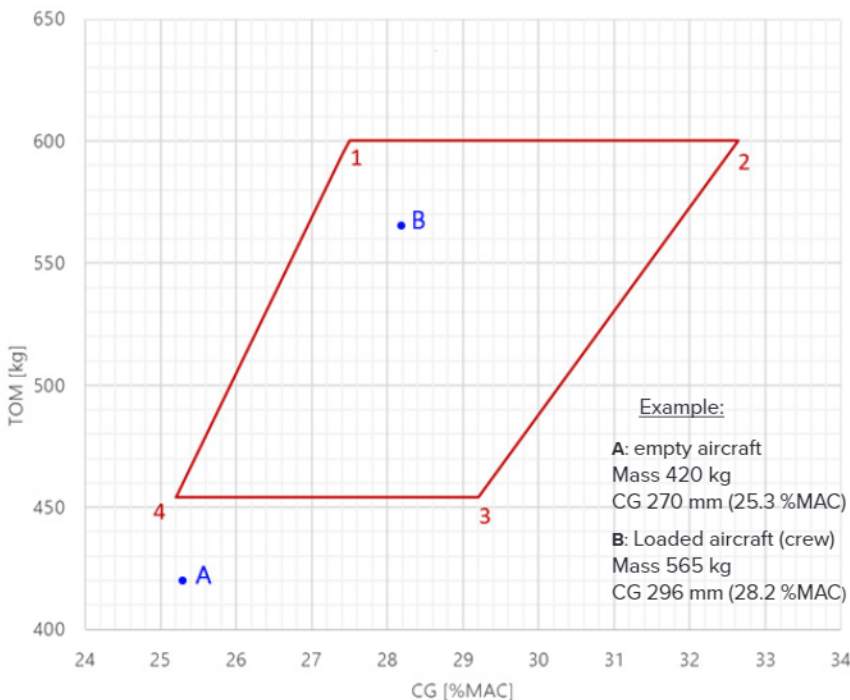

POINT	MASS [kg]	CG [% MAC]	CG [mm]
1	600	27.5	290
2	600	32.6	336
3	454	29.2	305
4	454	25.2	269

NOTE: on VELIS Electro the CG position is influenced only by crew weight. Mass and CG position are constant during the entire flight.



This page is intentionally left blank.

SECTION

7



SECTION 7 – AIRPLANE DESCRIPTION

TABLE OF CONTENTS

PART	SUBJECT	PAGE NUMBER
7.1	INTRODUCTION	7-5
7.2	AIRCRAFT STRUCTURE	7-5
	Fuselage	
	Wings	
7.3	Empennage	
	FLIGHT CONTROL SYSTEM	7-6
	Elevator Control System	
	Aileron Control System	
	Rudder Control System	
	Wing Flaps Control System	
7.4	Elevator Trim System	
	LANDING GEAR	7-8
	Main Gear	
	Nose Gear	
7.5	Brake System	
	AIRPLANE CABIN	7-9
	Cabin Doors	
	Ventilation	
	Seats	
7.6	Battery Compartment Access panels	
	Cabin Safety Equipment	
	PROPULSION SYSTEM	7-11
	Electric Engine	
	High Voltage Battery System	
	Propulsion System Cooling	
Engine Operating Controls		
System Controller		



PART	SUBJECT	PAGE NUMBER
	Data Logger	
	Propulsion System Monitoring Instruments	
	Propeller	
7.7	ELECTRICAL SYSTEM	7-24
	Electrical System	
	Low Voltage Power Generation	
	Power Distribution	
	Switches	
	Miscellaneous Components	
7.8	LIGHTING	7-27
	Exterior Lighting	
7.9	ENVIRONMENTAL SYSTEM	7-27
7.10	PITOT SYSTEM AND STALL WARNING	7-28
7.11	FLIGHT DECK ARRANGEMENT	7-28
7.12	FLIGHT INSTRUMENTS AND SYSTEMS	7-31
	Attitude indicator	
	Mechanical Airspeed Indicator (ASI)	
	Mechanical Altimeter (ALT)	
	Magnetic Compass	
	RPM Indicator	
	Vertical Speed Indicator (VSI)	
	Communication Transceivers (COM)	
	Transponder (XPDR)	
	Audio System	
	GPS	
7.13	EMERGENCY LOCATOR TRANSMITTER (ELT)	7-34



This page is intentionally left blank.



7.1 INTRODUCTION

This section provides a basic description and operation of the standard airplane and its systems.

7.2 AIRCRAFT STRUCTURE

7.2.1 FUSELAGE

VELIS Electro's fuselage and structural components are primarily made of carbon and glass fiber reinforced polymer (CFRP and GFRP), using aramid as inner laminate in the cockpit area. The undercarriage is fabricated using mostly GFRP and rovings for flexibility, and is attached directly to the fuselage, while the firewall is made of CFRP and has a ceramic insulation with 0.05 mm stainless steel on top. There is no baggage compartment in the fuselage. The rear battery pack compartment is located behind the cabin. It is accessible via the rear battery compartment door located on the left-hand side of fuselage. The fuselage nose is designed to accommodate the front battery pack in the front battery compartment, which is positioned in front of the cabin. It is accessible via two access doors on each side of the fuselage. The cabin backrest is made of CFRP. The cabin floor along with the lower seat structure are made of mostly of CFRP and aramid because of its impact absorption properties.

7.2.2 WINGS

The detachable wing is a single spar cantilever wing. Two bolts fasten the left and right wing together at the spar ends. The wing structure is made mostly of CFRP. The main spar shear web and root ribs are made from GFRP. This is for visual inspection and easier damage detection reasons. The spar caps are produced using STS 40 carbon roving, while the wing shell is designed as a 2-cell CFRP sandwich shell, which is closed by a rear shear web where the flaperons are fitted. A so-called blind jointing edge is what allows for the wing shells to be bonded to the wing nose. The wing spar is designed as a double-T-type spar. Lateral loads and twisting moments are conventionally transferred to the fuselage through root ribs and shear pins.

There is also the third middle bolt to provide torsion stiffness, mating the wings to the cabin support strut. The wings are attached with shear pins to bushings in the fuselage root ribs. The VELIS Electro wing does not have airbrakes installed.



7.2.3 EMPENNAGE

The empennage consists of a horizontal stabilizer, a single piece elevator, a vertical fin and a rudder. All of the empennage components are conventional spar (shear web), rib, and skin construction.

The horizontal stabilizer is attached to an aluminum bracket that is pivoted to the vertical stabilizer and can be removed. The shell of the horizontal tail is designed as CFRP sandwich. The horizontal tail is attached to an aluminum bracket at the back C-spar and a self locking bolt at the location of the front C-spar.

The elevator is designed as a bottom surface supported hinged flap. The elevator is actuated through a pushrod connected to the elevator control bracket. The elevator shell is designed as a 1-cell CFRP sandwich shell. The elevator is hinged in maintenance-free bushings mounted on stainless steel brackets at the stabilizer rear spar and bottom shell. Counterbalance weights are integrated into the elevator tips.

The vertical fin is designed to be one part with the tail fuselage, made of carbon honeycomb sandwich with carbon spars. The bending moment is carried by one C-type spar which is reinforced by CFRP tapes at the flanges.

The rudder is designed as a centrally supported hinged flap. The rudder shell is designed as single-cell GFRP sandwich shell. The rudder is hinged in two maintenance-free spherical plain bearings. Balancing weights are mounted at the front end of the rudder.

7.3 FLIGHT CONTROL SYSTEM

The aircraft uses conventional flight controls for ailerons, elevator and rudder. The control surfaces are pilot controlled through either of two control sticks positioned centrally in front of each pilot. The location and design of the control sticks allow easy, natural use by the pilots. The control system uses a combination of push rods, cables and bell cranks for control of the surfaces. Pitch trim are available through an electric button located on the central console.



7.3.1 ELEVATOR CONTROL SYSTEM

The sticks are mounted on a common lateral rod which actuates the elevator longitudinal pushrod, running the length of the fuselage behind the cockpit control levers. A bell-crank is located on the bottom side of the vertical fin and can be inspected through a provision in the vertical stabilizer end-rib. The hook-up to the elevator is via a U-member which conforms to the shape of the elevator. In case the horizontal tail plane is removed the U-member remains attached to the fuselage whereas the elevator remains attached to the horizontal stabilizer. There are no cables in the pitch control system. Control stops are integral to the transverse torque tube. Bob-weights are installed in order to provide adequate stick forces.

7.3.2 AILERON CONTROL SYSTEM

Roll control is achieved by torsional activation of flaperon control surfaces via an all-pushrod mechanisms. A conventional center control stick is available to each pilot. The sticks are mounted on a common lateral rod which actuates the elevator longitudinal pushrod. There is a bell-crank located on the bottom of the fuselage behind the seats which provides differential motion. The flap handle is connected to this bell-crank, allowing for symmetric displacement of flaperons. All elements of the roll control mechanism are attached to the fuselage, with the connection to the flaperon achieved via a self-fitting coupling attached to the flaperon axis directly. Roll Control stops are integral to the transverse torque tube.

7.3.4 RUDDER CONTROL SYSTEM

Rudder pedals are available to each pilot and are adjustable in-flight in a fore-aft sense. Metal cables in polyamide bowdens run from the individual pedal to bellcranks located behind the seats. Single cables run from the bellcranks backwards and are attached directly to the rudder.

The tension of the cables is adjusted with cable tensioners and rudder neutralization is achieved by means of two retaining springs attached to the cable junctions. The nose wheel is part of the yaw control system and is moved whenever the pedal is pressed. Cables for nose wheel steering run from the bellcranks behind the seats forward to the nose wheel hinge element, where a anti-shimmy damper is also connected to.



7.3.5 WING FLAPS CONTROL SYSTEM

There are no separate flap control surfaces in place. Operating the flaps is achieved through symmetric deflections of the flaperons. They are hand activated using control sticks available to both pilots, located in front of each seat. The flap handle can be spring locked in 3 positions, corresponding to flap deflections 0°, +9° and +19°. The positions are denominated, (0), (+1), (+2) respectively. The thumb-lock button prevents inadvertent handle movement. The aft end of flap handle connects to main flaperon bell-crank.

7.3.6 ELEVATOR TRIM SYSTEM

A spring type elevator trim is operated using a linear servo motor assembly located behind the rear battery compartment. Motion of the linear servo is controlled through a cockpit switch and an integral position sensor. The trim position is indicated with discrete steps on a dedicated LED display adjacent to the trim switch.

7.4 LANDING GEAR

7.4.1 MAIN GEAR

The landing gear is a conventional, fixed tricycle type. The main landing gear consists of a single composite landing gear strut made of GFRP. The strut is composed of two parallel elements producing a semi-redundant structure and allowing for predictable locations of stress points. Two supportive bridge struts are installed to reinforce the landing gear main strut attachment to the fuselage. The tube-less type wheel tire is 4.00 - 6", with a wheel track of 1.60 m and base of 1.58 m. Inflate it to 2.8 bar.

7.4.2 NOSE GEAR

The nose landing gear is fastened to the fuselage and firewall. It is steerable, connected to the rudder pedal control system and incorporates an oil-spring, shimmy-reducing damper element. The nose wheel tire is 4.00 - 4". The nose gear shock absorber is a spring-type oleo-strut that has an aluminum fork attached to the end of it. Inflate the nose wheel to 1.8 bar.

7.4.3 BRAKE SYSTEM

The main wheels are equipped with hydraulic disc brakes. Right and left brake are independent and activated by toe brakes on each set of rudder pedals. A parking brake, in the form of a center console lever, is accessible to both pilots.



The brake system consists of a master cylinder for each rudder pedal, two hydraulic fluid reservoirs, a parking brake valve, a single disc brake assembly on each main landing gear wheel and associated hydraulic plumbing. Braking pressure is initiated by pressing the lever on the top of the rudder pedal (toe brake). The brakes are designed so that pressing either of the pilot's or copilot's left or right toe brake will result in respective (left or right) main wheel braking. The reservoir is serviced with DOT-4 hydraulic fluid.

Brake system malfunction or impending brake failure may be indicated by a gradual decrease in braking action after brake application, noisy or dragging brakes, soft or spongy pedals, excessive travel, and/or weak braking action. Should any of these symptoms occur, immediate maintenance is required. If, during taxi or landing roll, braking action decreases, let up on the toe brakes and then reapply the brakes with heavy pressure. If the brakes are spongy or pedal travel increases, pumping the pedals may build braking pressure.

CAUTION: Do not pull the PARK BRAKE lever in flight. If a landing is made with the parking brake valve set, the brakes will maintain any pressure applied after touchdown.

The main wheel brakes are set for parking by using the PARK BRAKE lever on the left side of the console near the pilot's right ankle. Brake lines from the toe brakes to the main wheel brake calipers are plumbed through a parking brake valve. For normal operation, the lever is pushed forward. With the knob pushed forward, poppets in the valve are mechanically held open allowing normal brake operation. When the handle is pulled back, the parking brake valve holds applied brake pressure, locking the brakes. To apply the parking brake, set the brakes with the rudder-pedal toe brakes, and then pull the PARK BRAKE lever back.

7.5 AIRPLANE CABIN

7.5.1 CABIN DOORS

The windshield, upper window and doors'-windows are made from Lexan shatter-resistant polycarbonate. The fuselage has two cabin doors made out of CFRP, which are locked in the closed position via 3 locking pins operated simultaneously by rotating a common central handle.



7.5.2 VENTILATION

The system's primary source of fresh air is a set of sliding windows and adjustable vents that direct fresh ram air into the cabin. There is a sliding window door on the starboard side, an adjustable circular vent in the door on the port side and another adjustable circular cabin air exhaust in the sun roof.

7.5.3 SEATS

The seating arrangement consists of two seats, comprising of a bottom cushion and hard padded back panel. The back panel rests on the cockpit aft bulkhead. The seats are not adjustable and do not recline, however the back panel can be removed/reclined to access the rear battery compartment. The back panel features a manual pneumatic pump to adjust the size of the lumbar bladder and thus lumbar support.

7.5.4 HV BATTERY COMPARTMENT ACCESS PANELS

There are 3 high voltage battery compartment access panels: 2 in the front, on both sides of the fuselage and 1 in the back, behind the cabin on the left side. They are fastened to the fuselage by screws. The battery cooling intake is incorporated into the rear panel.

7.5.5 CABIN SAFETY EQUIPMENT

Passenger Restraints

The seatbelt harness is a 4 point restraint system with aviation style quick release buckle. The lap belts are attached to points in the cabin floor that are locally reinforced. The shoulder belts are attached to the top of the battery compartment bulkhead with an M8 bolt. These attachment points are reinforced with a composite rib.



7.6 PROPULSION SYSTEM

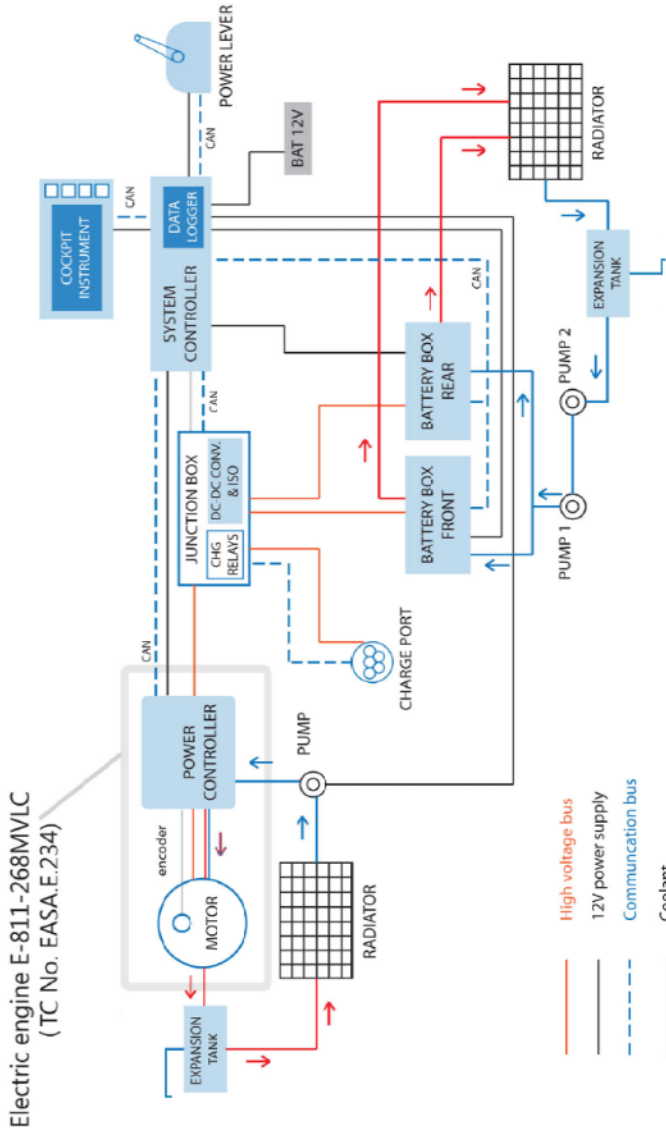

Electric engine E-811-268MVL
(TC No. EASA.E.234)

Propulsion system
diagram



7.6.1 ELECTRIC ENGINE

The aircraft is powered by the Pipistrel E-811-268MVL electric engine that houses the 268 MV LC VHML electric motor and Pipistrel's H300C power controller.

- Maximum rated continuous power 48 kW
- Maximum rated take off power 65 kW

MOTOR

The motor installed is the Pipistrel 268 MV LC VHML. It is an axial flux, synchronous permanent magnet electric motor, powered by three-phase alternating current, supplied by H300C power electronics. It is fitted with a temperature sensor and is liquid cooled.

Pipistrel electric motor 268 MV LC VHML characteristics:

- Maximal shaft speed 2500 RPM (electronically limited)
- Peak torque 220 Nm (0 – 2000 rpm)
- Motor efficiency 89%
- Temperature operating range between -20° C and +110° C
- Weight 23 kg
- Liquid-cooled (50% distilled water – 50% glycol G12+)

POWER CONTROLLER

The H300C power-electronics is a high voltage power controller, that converts direct current (DC) to a three-phase alternating current (AC) and supplies the motor with it.

Pipistrel H300C power controller characteristics:

- Operating temperature between -20° C and +70 °C
- Dimensions 230 x 245 x 126 mm, weight 8.1 kg (with cables)
- IP65 protection
- Liquid-cooled (50% distilled water – 50% glycol G12+)

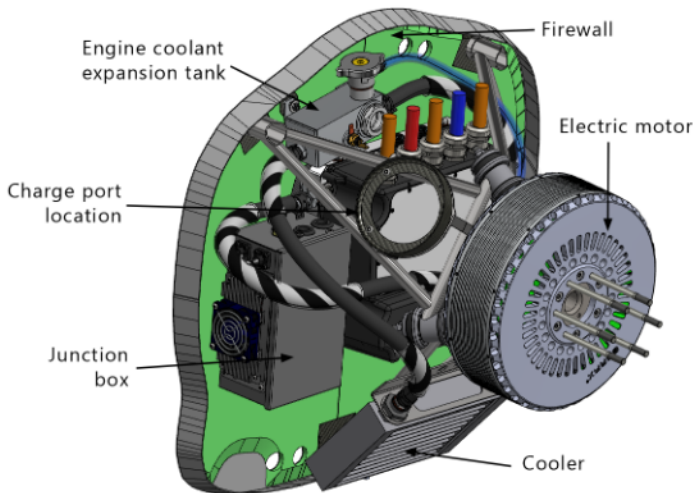
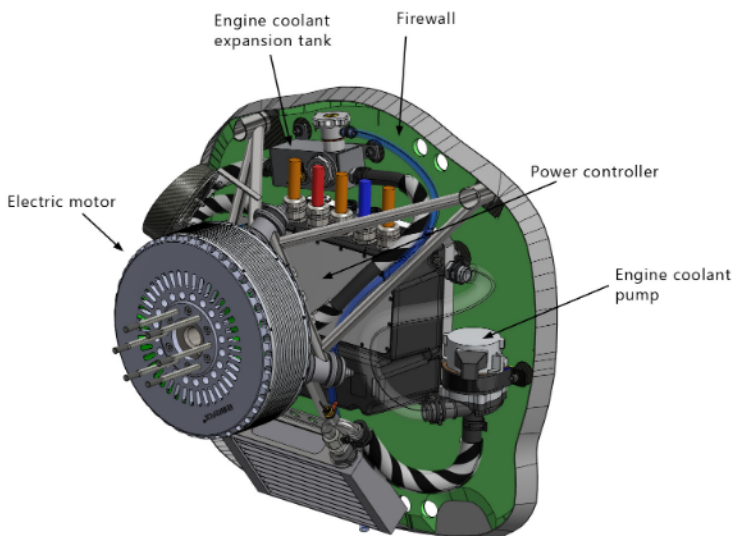

Engine system
installation



7.6.2 HIGH VOLTAGE BATTERY SYSTEM

VELIS Electro has a high voltage electric power system. The primary energy sources are two Pipistrel PB345V124E-L batteries. This ensures redundancy of the power-source. In case of battery failure, the faulty battery gets disconnected from the system. A single battery is capable of standalone operation and has enough power output capability to support climbing of the aircraft and continuation of flight (single battery operation is not considered normal procedure). Batteries can be charged via an on-board charging port. The electric charger is not part of the aircraft. The low voltage power system of the aircraft is powered by DC-DC converter. The high voltage power is distributed between the systems through a junction box. The main computer (system controller) controls and oversees operation of high and low voltage power system. Status of the system is displayed on the Pipistrel EPSI570C.

PARAMETER	VALUE (per pack)
Minimum voltage	260 V
Nominal voltage	345 V
Maximum voltage	394 V
Maximum discharge current	120 A
Maximum continuous discharge power	40 kW
Maximum charging current	40 A per battery pack
Operating temperature range (discharge)	0°C - 58°C
Operating temperature range (charge)	0°C - 45°C
Allowable temperature range for storage	0°C - 30°C
Rated capacity (@ 50°C, 20A discharge current)	35 Ah, 12 kWh
Rated capacity (@ 23°C, 20A discharge current)	33 Ah, 11 kWh
Rated capacity (@ 0°C, 20A discharge current)	32 Ah, 10.5 kWh
Cell type	Samsung INR18650-33G
Configuration	96S12P

The PB345V124E-L battery is composed by the following major components:

- Aluminum enclosure
- Battery cell modules
- Battery Management System (BMS)



- Electrical interfaces (power and data connectors)
- Coolant interface

High voltage battery system installation

The aft battery pack compartment is located behind the cabin. It is accessible via the rear battery inspection panel, bolted on the left side of the fuselage. The fore battery pack compartment is positioned in front of the cabin. It is accessible via the front inspection panels bolted on both sides of the fuselage. The batteries are liquid-cooled (50% water - 50% glycol G12+). The liquid-cooling system consists of a radiator and two electrically driven pumps, located behind the aft battery pack compartment.

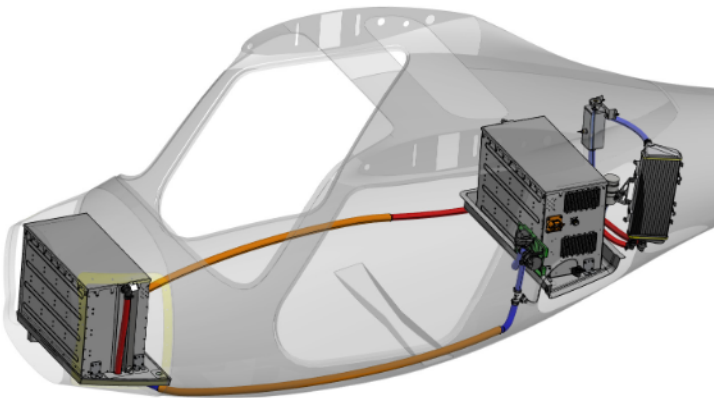

High voltage battery
system installation



BATTERY MANAGEMENT SYSTEM (BMS)

The PB345V124E-L battery includes a BMS, which monitors and controls various parts of the battery. It's built on a single PCB (Printed Circuit Board) assembly and is mounted on the front side of the battery's enclosure.

The BMS performs the following functions:

- Communication with the system controller (see section 7.6.5)
- Control of HV contactors and pre-charge circuitry
- Cooling system control and monitoring
- Monitoring of HV lines and current
- Battery cell voltage measurement and balancing functions
- SOC/SOH calculation
- Data logging
- Overvoltage, overcurrent, overtemperature protection

The BMS calculates the battery State Of Charge (SOC) and the State Of Health (SOH). The SOH calculation takes into account the decrease of battery capacity and increase of internal resistance, as a consequence of battery aging. CAN (Controlled Area Network) bus communication running at 500kBit/s is used for exchanging data with the system controller.

At all times, the BMS sends system status and various information to the system controller. Battery SOC, SOH, cell voltages, battery current and temperatures are reported at a rate of 5 Hz. Should any failure condition be detected, the BMS takes appropriate action and sends an error message to the system controller. Should the BMS master detect an overtemperature, overcurrent or overvoltage event, the master disconnects the main contactors, effectively protecting the system.

The BMS controls the main HV contactors and the pre-charge circuitry and the axial fans of the cooling system during ground operations (charge).



7.6.3 PROPULSION SYSTEM COOLING

Engine cooling

The electric motor and power controller are liquid-cooled (50% distilled water – 50% glycol automotive grade G12+). The liquid-cooling system consists of a radiator and one electrically driven pump. The system is in common for the motor and power controller.

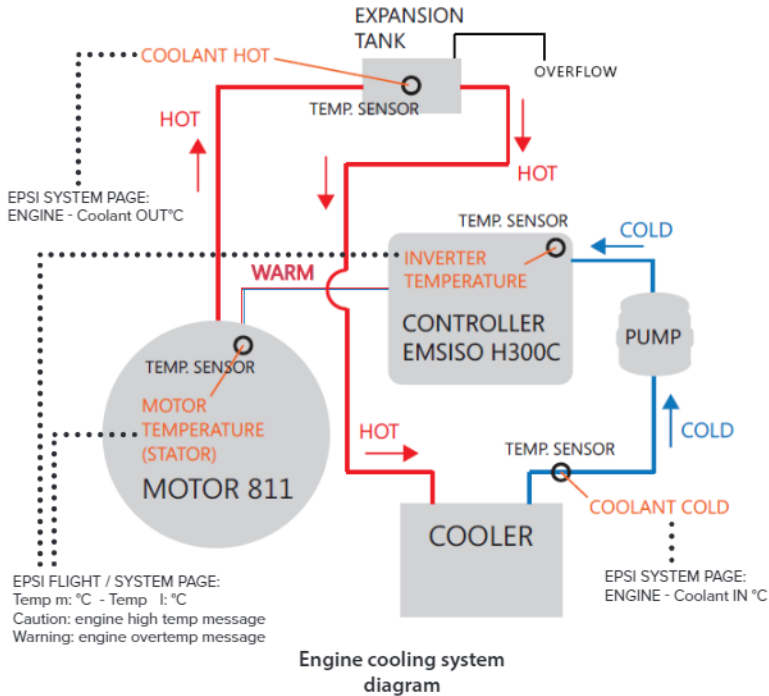

Battery system cooling

The batteries are liquid-cooled (50% distilled water – 50% glycol automotive grade G12+). The liquid-cooling system consists of a radiator and two electrically driven pumps, located behind the aft battery pack compartment. The air inlet for the radiator is located on the left side of the fuselage, integrated into the battery compartment access panel, whereas the hot exhaust is expelled from the bottom of the fuselage through an exhaust outlet. Small fans are installed behind the radiator in order to allow battery cooling during ground operations, such as charging.

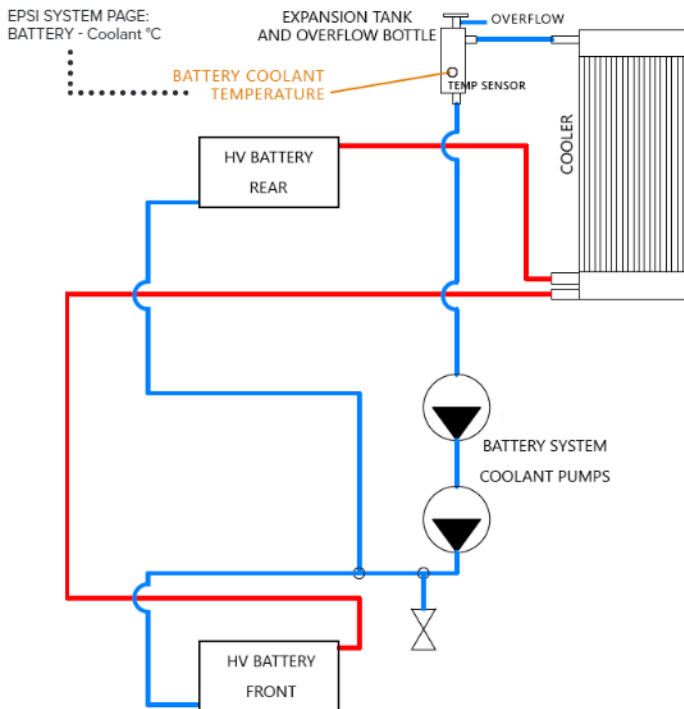

Battery cooling system
diagram

Cooling system for ground operations

Two high power axial fans mounted on the cooler are used to improve battery system cooling during the recharge. The fans are controlled and monitored by the BMS master. When the battery temperature rises above the 35 °C the fans start spinning and at 40 °C they reach full speed. Cooling fan malfunction triggers a caution message on EPISI570C display (see [Battery coolant fan failure 3.4.6](#)) and charging procedure (8.5).



7.6.4 ENGINE OPERATING CONTROLS

The engine controls on VELIS Electro are designed for an electric motor. A single power control lever with magnetic position sensor controls the motor power and is located in the central console. Power lever angular movement is about 90°, with full power position forward and cut off position aft.

The engine is designed so that it can't be started until the power lever is put in the cut-off position. This safety feature prevents accidental motor activation on the ground.



Power lever

Power derating

During normal operation, the power delivered by the motor is proportional to the lever position. However, during emergency operation (see also [Engine overtemperature 3.5.10](#)), when engine temperature enters warning range (power controller temperature ≥ 70 °C or motor temperature ≥ 110 °C), the system controller automatically reduces the maximum available power proportionally to overtemperature level. In this case power is reduced to preserve engine components and to limit further temperature increase. During this phase, the last portion of power lever travel might be ineffective, or power might be automatically reduced with no lever movement. Expect possible power fluctuations due to derating if high power is requested. The power lever should be used carefully and gradually. Full power will be available again after the temperatures have dropped out of the warning range. Expect imminent power cut to zero in case of high power usage!



7.6.5 SYSTEM CONTROLLER

The system controller performs the tasks of a Vehicle Management Computer (VMC). It is located on the electric panel, inside the instrument panel. Most of the functions are controlled by an on-board single core micro-controller, which handles all system communications in the aircraft as well as other analog/digital IO (Input-Output) functions.

The system controller performs the following functions:

- Master, Avionics and Drive SSR (Solid State Relay) control
- Auxiliary battery monitoring
- DC/DC converter interface
- Power controller / cooling system control and monitoring
- BMS / cooling system control and monitoring
- Power lever interface
- Switch panel interface
- Annunciator/Warning panel driver
- EPSI 570C Interface
- Charging port interface
- Garmin Aera 660 Interface
- Datalogger interface.

The system controller is responsible for coordinating operation of all the propulsion system components. Upon power-up, the system controller routes the 14V power supply from the auxiliary battery to all loads on the master and avionics DC-buses. After the BATT EN switch is turned ON, the system controller orders the high voltage batteries to go into the active state. Once the batteries have executed the activation sequence, the system controller enables the DC/DC converter to start charging the 14V auxiliary battery. Once the pilot activates the PWR EN switch, the system controller enables the power controller and sends the power lever settings to it. The system controller also executes the system shutdown in reverse order.



The system controller is also responsible for battery charging. Once the pilot connects the charging plug to the aircraft's charging socket, the system controller tries to establish communication with the charger. If the communication is established successfully, the system controller exchanges information with the charger about the type of battery on-board. After the pilot orders the charger to start charging, the system controller locks the charging plug, turns ON the charging relays and orders the batteries to go into active state. Charging may then begin. While charging, the system controller is responsible for all data interchange between the batteries and the charger.

7.6.6 DATA LOGGER

The aircraft is equipped with a data logger, which can be assimilated to a flight data recorder. It is an electronic board connected directly to the system controller, located behind the aircraft's instrument panel. The data logger records data from propulsion system, navigation system and other instruments. Data is always recorded to an internal micro SD card. The data-logger also has a USB host port, positioned on the right side of the instrument panel. Whenever a USB flash drive is inserted into the USB port, data can be logged into it in addition to the micro SD card. Please refer to Service document [7] for additional information about data-logger and data downloading procedure.

7.6.7 PROPULSION SYSTEM MONITORING INSTRUMENTS

The system controller collects data from the motor, power controller, high voltage batteries and other electrical systems and presents them on the EPSI570C display. 12 VDC for EPSI570C operation is supplied through the EPSI circuit breaker.

EPSI570C DISPLAY

The EPSI570C (Electric Propulsion System Instrument) is the main source of information for the pilot about the operational state of the electric propulsion system in the aircraft. It presents various operational parameters and values of individual components in the system via a 5.7 inch color LCD display.

NOTE: For additional information on the EPSI570C see APPENDIX 9-A1 EPSI570C SYSTEM DESCRIPTION.

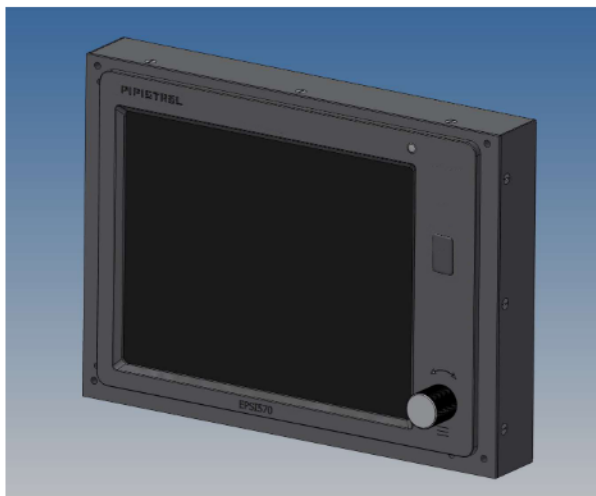

EPSI570C display

ANNUNCIATOR PANEL

The annunciator warning panel is mounted on the instrument panel. It alerts the pilot about propulsion system faults/issues and provides redundancy if the EPSI570C fails. The panel is managed by the BMS software and replicates warning/cautions that are displayed on EPSI570C. See Appendix 9-A1 EPSI570C SYSTEM DESCRIPTION for additional information.

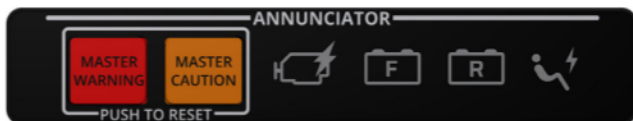

Annunciator panel

NOTE: Annunciator panel lights (buttons and icons) are subjected to a self test at system start-up (MASTER switch ON). See [self test description](#) in this section for details.



FRONT/REAR BATTERY OVERTEMPERATURE WARNING LIGHT

The two red LED lights installed on the left side of the annunciator panel are connected to overtemperature sensors inside the battery boxes. The system operates independently from the BMS software. In case of battery overtemperature ($> 58\text{ }^{\circ}\text{C}$) the LED light of the affected battery turns ON (see Section 3 - Emergency procedures - for details).

NOTE: Battery overtemperature analog warning lights are independent from the EPSI and do not directly trigger any annunciator light nor warning message.

Battery overtemperature warning lights are subjected to a self test at system start-up, when MASTER switch is set ON. See [self test description](#) in this section for details.



Battery overtemperature warning lights



SECTION 7

AIRPLANE DESCRIPTION

SELF TEST DESCRIPTION

A self test is activated every time the MASTER switch is set ON. This typically happens during the pre-flight check and at start-up. The self test gives the pilot the opportunity to verify that annunciator lights, battery overtemperature panel lights and haptic stall warning are functional.

As MASTER switch is turned ON, the following systems are tested at the same time, for few seconds:

- BATT OVERTEMP panel: LED lights (2x) are activated for few seconds, then go off.
- ANNUNCIATOR panel: MASTER CAUTION and MASTER WARNING buttons are illuminated for few seconds, then go off.
- ANNUNCIATOR panel: system icon lights (4x) are illuminated for few seconds, then go off.
- CONTROL STICK HANDLES: haptic stall warning is activated for few seconds with intermittent pulses.



Immediately after the MASTER switch is turned ON, the Pilot has to verify that ALL the annunciator and battery overtemperature panel lights are active during the self test, and that haptic stall warning in the control stick handles is functional.

If any of these items is not illuminated/activated during the self test, it indicates a malfunction (e.g. LED light or stall warning damage) and self test has FAILED. DO NOT TAKE OFF: abort mission and contact CAMO/CAO.



7.6.8 PROPELLER

VELIS Electro is equipped with the 3-blade, fixed pitch Pipistrel P-812-164-F3A propeller. Its diameter is 1640 mm. The blades are made from carbon fiber composite material and stainless steel. The blade root and propeller hub are machined aluminum parts.

7.7 ELECTRICAL SYSTEM

7.7.1 ELECTRICAL SYSTEM

The airplane is equipped with a high and low voltage system. The high voltage electrical system, powered by the two high voltage batteries, is used for propulsion (see section 7.6.2 High voltage battery system). The low voltage battery system is used to power avionics and system controllers on the aircraft. Low voltage power is generated from high voltage batteries by a DC/DC converter. An auxiliary 12V battery is also present, installed on the cabin bulkhead behind the switch panel.

A junction box, installed in the engine compartment, houses the DC/DC converter, charging relays and fuses, and merges the high voltage cables from the batteries, charging port and power controller.

7.7.2 LOW VOLTAGE POWER GENERATION

The avionics electrical system is a 12-14 V DC system. Power is supplied through a DC/DC converter that converts the 345 V DC from the high voltage batteries to the 14 Volt for the avionics and for recharging the auxiliary battery (13.2V, 12,4 Ah). The DC/DC converter is located in the junction box, in the engine compartment of the aircraft. In case of emergency and loss of



power from both propulsion batteries, the auxiliary battery can power the systems for at least 30 minutes. The electrical system is controlled by means of switches/fuses that are located on the switch panel. The circuit breakers (CB) are located under the switch panel. Ammeter and Voltmeter indications are integrated into the EPSI570C display.

7.7.3 POWER DISTRIBUTION

The system is controlled by means of switches and circuit breakers. The main 345 V DC power bus is converted to 14 V DC before entering the cabin, so there are no high voltage buses going through the cabin. The 14 V bus keeps the battery charged and the avionics working. If power is lost, the auxiliary battery keeps the avionics system working. The 14 V DC bus is split into different buses, each with a separate master switch or breaker, with each element then subsequently equipped with its own circuit breaker with an appropriate rating.

BREAKER	DESCRIPTION	BUS	RATING
AUX BATT	Auxiliary battery	BAT	35 A
DC/DC CONV	DC/DC converter	DC CONV	30 A
BATT FRONT	High voltage battery - Front	ENGINE	7.5 A
BATT REAR	High voltage battery - Rear	ENGINE	7.5 A
BATT FAN	Battery cooling fan (ground op.)	ENGINE	15 A
BATT PUMP F	Battery coolant pump - first	ENGINE	3 A
BATT PUMP R	Battery coolant pump - second	ENGINE	3 A
PWR CTRL	Power controller	ENGINE	4 A
INV PUMP	Engine coolant pump	ENGINE	10 A
COM	COM - Radio	AVIONICS	4 A
CHG	Charging port	ENGINE	3 A
XPDR	XPDR - Transponder	AVIONICS	3 A
GPS	GPS - Aera 660	AVIONICS	3 A
EPSI	EPSI570C display	ENGINE	2 A
INSTR	Instruments	AVIONICS	2 A
SYS CTRL	System Controller	BAT	1 A
TRIM	Electric trim system	MASTER	1 A



7.7.4 SWITCHES

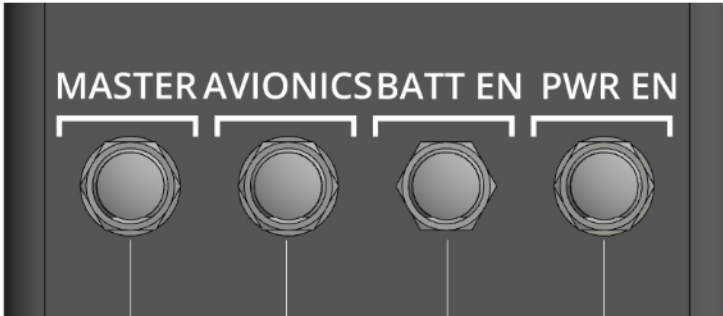

Switch panel - main switches

MASTER Switch

The MASTER toggle Switch activates the relay to connect the 14V battery with main bus. The main bus supplies the avionics relay, which delivers the power to the switch panel and circuit breakers. To check or use avionics equipment or radios while on the ground, the AVIONICS power switch must also be turned on.

AVIONICS Switch

A toggle switch, labeled AVIONICS, controls electrical power from the main bus to the Avionics Bus.

Typically, the switch is used to energize or de-energize all avionics on the Avionics Bus simultaneously. With the switch in the OFF position, no electrical power will be applied to the avionics equipment, regardless of the position of the master switch or the individual equipment switches.

For normal operations, the AVIONICS switch should be placed in the OFF position prior to activating the MASTER switch.



SECTION 7

AIRPLANE DESCRIPTION

BATT EN Switch

This switch connects the high voltage batteries to the electrical system, activates the DC/DC controller and routes HV power into the power controller.

PWR EN Switch

This switch activates the power controller output and the power lever.

7.7.5 MISCELLANEOUS COMPONENTS

Convenience Outlets

A 5V USB dual socket is installed on the left side of instrument panel. The receptacles accept standard USB plugs. The outlet may be used to power portable equipment non essential to flight. Amperage draw through the outlet must not exceed 2 A. Power to the convenience outlet is activated by the MASTER switch.

7.8 LIGHTING

7.8.1 EXTERIOR LIGHTING

The aircraft is not equipped with external lights.

7.9 ENVIRONMENTAL SYSTEM

Cabin passive ventilation

The primary source of fresh air is a set of sliding windows and adjustable vents that direct fresh ram air into the cabin. There is a sliding window door on the starboard side, an adjustable circular vent in the door on the port side and another adjustable circular outlet in the sunroof. There is no cabin heating system on the aircraft.



7.10 PITOT SYSTEM AND STALL WARNING

The pitot-static system consists of a single pitot tube mounted on the starboard wing, approximately 3 meters from the fuselage and dual static ports mounted on the fuselage, just below the aft battery compartment. The pitot tube drives total pressure to both to the Kanardia Horis (AH), the transponder and the altitude/airspeed indicators. The pitot tube also has a AOA sensing port. The aircraft is equipped with a stall warning system that activates a control stick vibration and aural warning when the critical AOA is approached. An aural warning is emitted by the EPSI570C speaker and is also heard in the headsets. The haptic system functionality is tested during initial self-test (initiated when master switch is set to ON), see section 7.6.7 for details.

7.11 FLIGHT DECK ARRANGEMENT

Instrument Panel

A mechanical altimeter and airspeed indicator are in the top segment of the instrument panel and serve as the main indicators.



Instrument panel



Switch Panel

The following depicts the switch panel and the table below indicates which switches/circuit breakers it incorporates:

MASTER	Enable system - switch
AVIONICS	Enable instruments - switch
BATT EN	Battery enable - switch
PWR EN	Power enable - switch
DC/DC CONV	DC/DC Converter circuit breaker
AUX BATT	Auxiliary battery circuit breaker
TRIM	Trim actuator circuit breaker
EPSI	EPSI570C display circuit breaker
COM	Radio COM circuit breaker
XPDR	Transponder circuit breaker
INSTR	Other instruments circuit breaker
GPS	Navigation Aera 660 system circuit breaker
BATT FRONT	Front HV Battery circuit breaker
BATT REAR	Rear HV Battery circuit breaker
BATT FAN	Battery fans circuit breaker
BAT PUMP F	HV battery coolant pump 1 circuit breaker
BAT PUMP R	HV battery coolant pump 2 circuit breaker
PWR CTRL	Power controller circuit breaker
SYS CTRL	System controller circuit breaker
INV PUMP	Engine coolant pump circuit breaker
CHG	Charging port circuit breaker



Switch panel

Center Console

The center console contains (front-to-back) the parking brake lever, power lever, elevator trim switch/indicator and the flap lever. On the back wall, above the flap handle, there is the cabin flood light.



7.12 FLIGHT INSTRUMENTS AND SYSTEMS

The standard instruments/avionics configuration consists of:

1	RPM Indicator Kanardia
2	AH (Artificial Horizon - attitude indicator) Kanardia Horis
3	GPS Garmin Aera 660
4	Vertical speed indicator Kanardia
5	Propulsion System Information EPSI570C
6	Warning panel (annunciator) and battery overtemperature warning lights by Pipistrel
7	Altimeter Mikrotechna LUN1128 (Mechanical Altimeter) - PRIMARY FLIGHT INSTRUMENT
8	Airspeed Indicator Mikrotechna LUN1116 (Mechanical ASI) - PRIMARY FLIGHT INSTRUMENT
9	Radio COM Funke ATR833
10	Transponder Funke TRT800H
11	ELT Artex ELT 345 + remote panel
12	Mechanical Compass
13	Turn coordinator - Slipball Winter
15	Switches and breakers

7.12.1 ATTITUDE INDICATOR

The attitude indicator/artificial horizon (AH) Kanardia Horis gives a visual indication of flight attitude. It consists of a set of sensors and an LCD display. The majority of sensors are built into its compact housing. One push/rotate knob is used to operate it. The user interface is optimized so only minimal interaction is required to operate the instrument. Please refer to [6] for additional information about use and settings.



7.12.2 MECHANICAL AIRSPEED INDICATOR (ASI)

The airspeed indicator (ASI) is TSO'd and is regarded as a primary flight instrument and located on the pilot's instrument panel. The instrument senses difference in static and Pitot pressures and displays the result in knots on an airspeed scale. It's a mechanical instrument and does not require electrical power to function.

7.12.3 MECHANICAL ALTIMETER (ALT)

The altimeter (ALT) is TSO'd and is regarded as a primary flight instrument. Airplane altitude is depicted on a conventional, three-point, barometric altimeter. The instrument senses the local barometric pressure adjusted for altimeter setting and displays the result on the instrument in feet and does not require electrical power to function. Barometric windows on the instrument's face allow barometric calibrations in either inches of mercury (inHg) or millibars (mb). The barometric altimeter settings are input through the barometric adjustment knob at the lower left of the instrument.

7.12.4 MAGNETIC COMPASS

A conventional, liquid filled magnetic compass is installed on the metal frame above the instrument panel. A compass correction card is installed with the compass.

7.12.5 RPM/POWER INDICATOR

The RPM/power indicator is a 57 mm (2¼") unit which displays the current RPM with both a familiar mechanical needle as well as a large OLED digital display. Motor power is also indicated on the display. Digit colors are white, but turn yellow or red when parameters are in caution or warning range. The information is also available on the EPSI570C display as primary info.

7.12.6 VERTICAL SPEED INDICATOR (VSI)

The variometer is a 57 mm (2¼") unit and consists of a familiar needle and OLED digital display. The needle shows if the aircraft is climbing or descending.



7.12.7 COMMUNICATION TRANSCEIVER (COM)

A VHF communication (COM) transceiver is installed to provide VHF communication. The transceiver and integrated controls are mounted in the Funke ATR833S-II-OLED unit. The Funke ATR833S-II-OLED is designated as COM. COM provides transceiver active and standby frequency indication, frequency memory storage, and knob operated frequency selection. The COM transceiver provides either 25 kHz spacing or 8.33 kHz spacing operation. The COM antenna is located on top of fuselage behind the cabin. 12 VDC for COM transceiver operation is controlled through the avionics switch and supplied through the COM circuit breaker on the switch panel.

7.12.8 TRANSPONDER (XPDR)

The airplane is equipped with a single Funke TRT800H-OLED Mode S transponder with squawk capability. The transponder system consists of the integrated receiver/transmitter control unit, an antenna and an integrated altitude encoder. The transponder and integrated controls are mounted on the instrument panel. 12 VDC for transponder operation is controlled through the Avionics Switch. 12 VDC for XPDR operation is supplied through the XPDR circuit breaker on the switch panel.

7.12.9 AUDIO SYSTEM

The airplane is equipped with an intercom system as part of the COM unit. A separate designated intercom ON/OFF switch is installed on the instrument panel.

Headset/Microphone Installation

The airplane is equipped with provisions for two headsets with integrated microphones. The microphone-headsets use remote Push-To-Talk (PTT) switches located on the top of the associated control stick grip. The microphone (MIC) and headset jacks for the pilots are located on the instrument panel. The volume is controlled via the COM unit and intercom function via the dedicated intercom switch.

7.12.10 GPS

The airplane is equipped with a Garmin Aera 660 display. It is a portable navigator with a 5-inch touch display. It comes preloaded with flight mapping, terrain and obstacle alerting.



7.13 EMERGENCY LOCATOR TRANSMITTER

The airplane is equipped with a self-contained emergency locator transmitter (ELT) Artex 345. The transmitter is installed on the fuselage's internal side behind the pilot's seat and is accessible by folding the left seat. A remote switch and indicator panel is installed on the instrument panel and provides manual activation, testing and monitoring functions for the ELT.

If rapid deceleration, such as an impact or crash landing, is detected, the transmitter will repeatedly transmit VHF band audio sweeps at 121.5 MHz and 406 MHz for 24 hours or until manual deactivation.

The main transmitter and the remote switches have three positions labeled ON, ARM/OFF, TEST. A red LED light on the transmitter and on the remote switch panel flashes when the ELT is transmitting, or to signal functional abnormalities.

The TEST button is used to periodically test the unit in accordance with OEM [2] procedures.

	Remote switch position		ELT transmitter switch position
Normal operation (automatic activation):	ARM/OFF	and	ARM/OFF
Manual activation:	ON	or	ON
Periodical test:	TEST	or	TEST
End transmission:	ON >> ARM/OFF	or	ON >> ARM/OFF

- In the event of imminent emergency landing:

- 1 Start ELT transmission manually: remote switch "ON". Status LED on the remote switch will start flashing.

- In the event of an accident, crash landing or hard landing:

- 1 ELT transmission is automatically activated by the G-force detector. Status LED on the remote switch will start flashing.



SECTION 7

AIRPLANE DESCRIPTION

Consult OEM [2] for additional information about ELT use.

NOTE: If the ELT is inadvertently activated in its distress mode, the operator should deactivate it AND contact the nearest COSPAS-SARSAT Mission Control Centre or local RCC as soon as possible to request cancellation of the distress alert (Deactivating the ALT alone does NOT cancel the distress alert that already has been transmitted by the beacon and received by COSPAS-SARSAT).



ELT transmitter location

SECTION

8



SECTION 8 – HANDLING AND SERVICING

TABLE OF CONTENTS

PART	SUBJECT	PAGE NUMBER
8.1	INTRODUCTION	8-3
8.2	AIRPLANE INSPECTION PERIODS	8-3
8.3	PILOT CONDUCTED MAINTENANCE	8-3
8.4	CHANGES AND REPAIRS	8-3
8.5	RECHARGING	8-4
	Approved Chargers	
	Charger Functions	
	Full Charge Procedure	
	Rest Charge Procedure	
8.6	SERVICING	8-10
	Tire Servicing	
	Brake Servicing	
	Propeller Servicing	
8.7	GROUND HANDLING	8-11
	Towing / Ground Movements	
	Taxiing / Ground Movements	
	Parking	
	Tie Down	
	Hoisting	
8.8	CLEANING	8-14
	Cleaning Exterior Surfaces	
	Cleaning Interior Surfaces	



8.1 INTRODUCTION

The airplane owner should establish contact with a Pipistrel dealer or certified service station for service and information. All correspondence regarding the airplane must include its serial number (see tail-mounted type data plate). A maintenance manual with revision service may be procured by the manufacturer.

8.2 AIRPLANE INSPECTION PERIODS

As required by national operating rules all airplanes must pass a complete annual inspection every twelve calendar months. In addition to the annual inspection airplanes must pass a complete inspection after every 100 hours.

The airworthiness authority may require other inspections by the issuance of airworthiness directives applicable to the aircraft, motor, propeller and components. The owner is responsible for compliance with all applicable airworthiness directives and periodical inspections.

8.3 PILOT CONDUCTED MAINTENANCE

Pilots operating the airplane should refer to the regulations of the country of certification for information about preventative maintenance that may be performed by pilots. This maintenance may be performed only on an aircraft that the pilot owns or operates and which is not used in air carrier service. All other maintenance required on the airplane is to be accomplished by appropriately licensed personnel. A licensed maintenance company should be contacted for further information. Preventative maintenance should be accomplished with the appropriate service manual.

8.4 CHANGES AND REPAIRS

Only licensed personnel is permitted to perform changes or repairs. Changes to the aircraft must be performed in coordination with the manufacturer and the authority, with the intention of protecting the aircraft's airworthiness state. More detailed information regarding repairs can be found in the maintenance manual.



8.5 RECHARGING

NOTE: Please refer to [8] for detailed charging procedure safety information and guidelines.

WARNING: During charging, crew and ground personnel must stay at a safe distance from the aircraft! Being on board while charging is prohibited!

WARNING: Monitor the aircraft while charging, do not leave it unattended, unless alternative means are in place.

WARNING: Keep a water hose close to the aircraft during charging (or equivalent equipment).

WARNING: Do not start battery recharging process if the battery temperature is $<+0\text{ }^{\circ}\text{C}$ or $>+45\text{ }^{\circ}\text{C}$ (See also chapter 2 - Limitations).

WARNING: Do not start recharging a battery in undervoltage condition (e.g. battery disconnected due to undervoltage during the previous flight), or if batteries sustained damage, crash or impacts with external objects.

CAUTION: If the aircraft is under the sunlight and/or OAT is close to the highest allowed, selecting a low charger input current is recommended. This ensures less thermal stress on the battery cells (longer battery life) and more safety margin for the next flight.

8.5.1 APPROVED CHARGERS

The following chargers are approved:

Portable charger - p/n: 7020100000 TC charger 20kW GB T

Skycharge station - p/n: 8010200000 Charger Skycharge Gen1 EU

WARNING: Only use approved chargers!

NOTE: the pictures and charging procedures in this section are specifically applicable to the portable charger type.



8.5.2 CHARGER FUNCTIONS

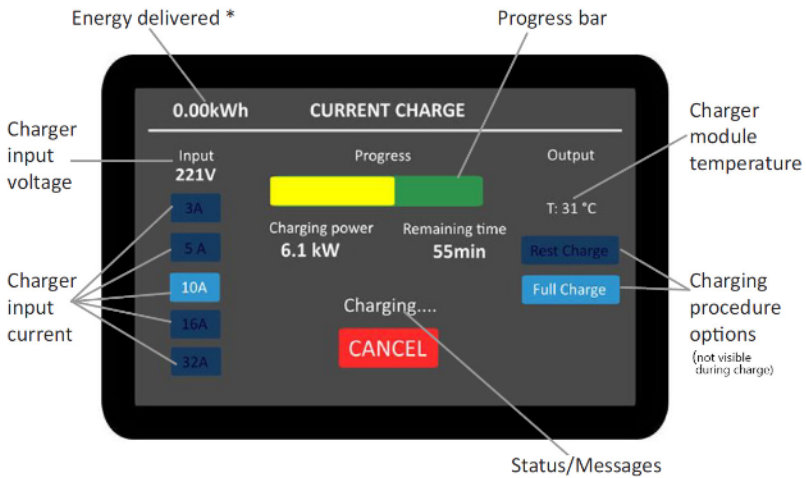

***NOTE:** the "Energy delivered" parameter indicates the amount of energy transferred since the beginning of the current charging process. It does not represent the total amount of energy in the batteries. For this parameter refer to %SOC.

8.5.3 FULL CHARGE PROCEDURE

Full charge is the standard charging procedure performed before the flight.

- 1 Park the aircraft and engage parking brake
- 2 Connect charger to the grid
- 3 Power-up the charger switching the charger's rocker switch ON
- 4 Open charging port door on the upper motor cowling of the aircraft
- 5 Connect charger to the aircraft charging port
- 6 Select "FULL CHARGE" option on charger display
- 7 Select desired charging current input from the left-side list (low charging current increases charging time, but reduces battery stress and heating)
- 8 Start charge by pressing "CHARGE" on charger display

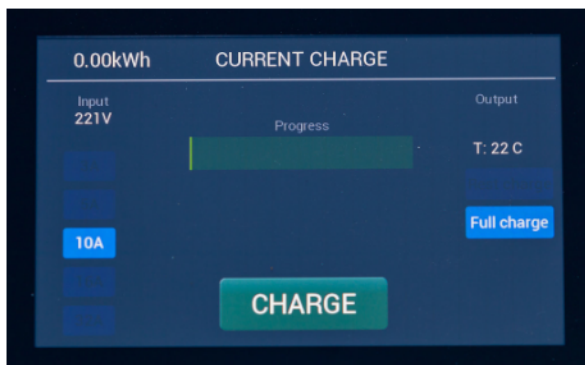

Charger display:
charging mode and input current selection

Once the charging procedure has started, the battery coolant pumps will turn ON. Depending on battery temperature, also the cooling fans are activated. Charging options (full charge or rest charge) will disappear from the charger display once the process has started, and "CHARGE page" will appear on EPSI570C display.

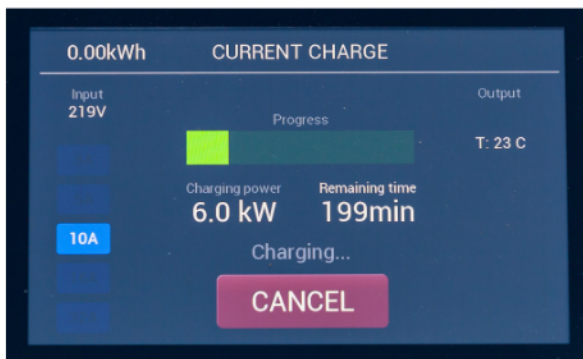

Charger display during charging process

NOTE: charging power is automatically derated (reduced) if battery temperature rises above +45 °C, or falls below +20 °C during the charging process.



- 9** When recharging is completed ("CONFIRM" button visible on charger display and 100% progress bar on EPSI570C): end charging process by pressing "CONFIRM" on charger display.

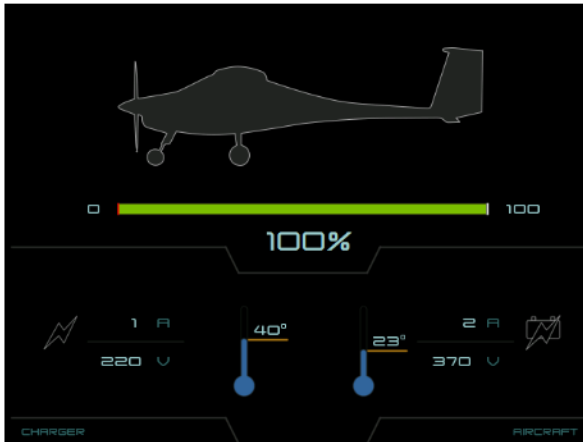

EPSI570C display during charge process -
example: charge 100% (completed)



Charger display at the end of
charging process

- 10** CHECK EPSI570C display for presence of caution/warning messages*
- 11** Disconnect charging plug from aircraft charging port



- 12 Close charging port door on the aircraft motor cowling
- 13 Turn the charger off by switching the rocker switch OFF
- 14 Disconnect the charger from the grid

***CAUTION:** In case of malfunctions during the charging process, the "CHARGE page" on the EPSI570C is temporarily replaced by the "FLIGHT page", with caution or warning message/s displayed. The annunciator is illuminated as well, and the message is accompanied by an aural warning. The "FLIGHT page" will remain until message acknowledgment (see appendix 9-A1 for details about EPSI570C messages).

In case of battery coolant pump and/or fan malfunction or battery overtemperature during charge, the charging power is set to 0 kW and charging process is interrupted. In case of other malfunctions the full charge will be completed. Write down the caution/warning messages presented on EPSI570C before acknowledging them and before unplugging the charger from the aircraft charging port.

WARNING: Do not take off if any caution/warning messages appear during charging phase. Contact CAMO/CAO.

CAUTION: Make sure that EPSI570C display is returned to normal FLIGHT/SYSTEM page mode after the charging process is completed successfully. Do not take off if CHARGE page is still active. Try to re-start the system to correct the problem. If the issue persists, contact CAMO/CAO.

8.5.4 REST CHARGE PROCEDURE

Rest charge is used to prepare the batteries for a period of inactivity. Rest charge is an option to "full charge", on the charger display. This process will charge the batteries to a optimum level for aircraft storage (SOC 70-80% at the end of the rest charge process. SOC range for battery storage is 30-80 %SOC). The procedure should be repeated every 90 days, during storage period, to maintain the batteries in optimal conditions.

To perform "REST CHARGE" procedure, follow the same procedure as "FULL CHARGE", but press "REST CHARGE" option at the beginning of the charging process.



Safety notes related to battery recharging procedure

Emergencies: FIRE

WARNING: Be aware that lithium battery fires are extremely dangerous because they are self-sustaining! They are the result of chemical reactions and can't be extinguished! Smoke produced during the combustion is dangerous.

- 1 Remove any source of heat and stop the recharging process immediately
- 2 Vacate the area around the aircraft
- 3 Douse the fire with as much water as possible in order to delay fire propagation

Emergencies: SMOKE

WARNING: Stay away from the aircraft because the batteries may self-ignite!

- 1 Remove any source of heat and stop the recharging process immediately
- 2 Vacate the area around the aircraft

General notes:

- Keep flammable liquids away from the aircraft
- Position the aircraft so that the charger cables do not interfere with other airport or hangar operations
- Have a long range water-type fire extinguisher nearby
- Stay in the vicinity of the aircraft. Never leave it completely unattended
- Verify charging status before removing charging cables



8.6 SERVICING

8.6.1 TIRE SERVICING

The main landing gear wheel assemblies use 4.00 x 6 tires. The nose wheel assembly uses a 4.00 x 4 tire. For maximum service from the tires, keep them inflated to the proper pressure.

Nose wheel tire:	Inflate to 1.8 bar
Main wheel tires:	Inflate to 2.8 bar

When checking tire pressure, examine the tires for wear, cuts, nicks, bruises and excessive wear.

8.6.2 BRAKE SERVICING

Brake Hydraulic Fluid Replenishing

The brake system is filled with DOT-4 hydraulic brake fluid. The fluid level should be checked at every oil change and at the annual / 100 h inspections, replenishing the system when necessary.

To replenish brake fluid:

1	Chock tires and release parking brake
2	Clean area on rudder pedals around cap before opening reservoir cap itself
3	Remove cap and add DOT-4 hydraulic fluid
4	Perform brake lines bleeding procedure *
5	Install cap, check brakes, inspect area for leaks

* NOTE: Brake lines bleeding procedure can be found in Aircraft Maintenance Manual [5].

8.6.3 PROPELLER SERVICING

The spinner and backing plate should be cleaned and inspected for cracks frequently. Before each flight the propeller should be inspected for dents, scratches, as well as corrosion on visible metal parts. If found, they should be repaired as soon as possible by a rated mechanic, since a nick or scratch causes an area of increased stress which can lead to serious cracks or the loss of a propeller tip. Refer to Propeller Manual [4] for detailed information.



8.7 GROUND HANDLING

8.7.1 TOWING / GROUND MOVEMENTS

Towing is not approved. For ground movements the following applies.

CAUTION: While pushing the aircraft backward, the nose-wheel must be off the ground to keep the nose wheel from turning abruptly. Do not use the tail vertical or horizontal control surfaces or stabilizers to move the airplane. Grab the tail cone in front of the vertical fin to push and maneuver. Wing roots can be used as push points. Do not push or pull on wing control surfaces or propeller to maneuver the airplane. Do not move the airplane when the main gear is obstructed with mud or snow.

Observe:

- 1 Be especially cognizant of hangar door clearances
- 2 Release parking brake and remove chocks
- 3 Move airplane to desired location by grabbing on the tail cone
- 4 When moving backward, lower the tail to keep nose wheel off the ground
- 5 Install chocks when repositioning complete

To obtain a minimum radius turn during ground handling, the airplane may be rotated around either main landing gear by pressing down on a fuselage just forward of the horizontal stabilizer to raise the nose wheel off the ground.

8.7.2 TAXIING / GROUND MOVEMENTS

Before attempting to taxi the airplane, ground personnel should be instructed and authorized by the owner to taxi the airplane. Instruction should include motor starting and shutdown procedures in addition to taxi and steering techniques. All Normal procedures apply.

CAUTION: Verify that taxi and propeller blast areas are clear before beginning taxi.



Do not operate the motor at high RPM when running up or taxiing over ground containing loose stones, gravel, or any loose material that may cause damage to the propeller blades. Taxi with minimum power needed for forward movement. Excessive braking may result in overheated or damaged brakes and/or fire. Observe wing clearance when taxiing near buildings or other stationary objects. If possible, station an observer outside the airplane. Avoid holes when taxiing over uneven ground.

1	Remove chocks
2	Start motor in accordance with Starting Motor procedure
3	Release parking brake
4	Advance power lever to initiate taxi. Immediately after initiating taxi, apply the brakes to determine their effectiveness
5	Taxi airplane to desired location
6	Shut down airplane and install chocks and tie-downs

8.7.3 PARKING

For parking:

1	Head airplane into the wind if possible
2	Retract flaps to (0)
3	Set parking brake by first applying brake pressure using the toe-brakes and then pulling the PARKING BRAKE knob aft
4	Chock both main gear wheels
5	Tie down airplane
6	Install a pitot head cover
7	Fold the bottom part of the seat up (vertically) to prevent any moisture from accumulating below the seat
8	Cabin doors should be locked. Lock doors at own discretion

CAUTION: Care should be taken when setting overheated brakes or during cold weather when accumulated moisture may freeze a brake.



8.7.4 TIE-DOWN

- 1 Head the airplane into the wind if possible.
- 2 Retract flaps to (0)
- 3 Chock the wheels
- 4 Attach tie-down rings
- 5 Install propeller holding device
- 6 Secure tie-down ropes to the wing tie-down rings and to the tail ring at approximately 45° angles to the ground

CAUTION: The tie down anchor points should not be more than 5 m apart to prevent tie down ring damage in heavy winds.

8.7.5 HOISTING

Hoisting the aircraft is only necessary in a few instances, such as when the landing gear has failed or the aircraft's fuselage is badly damaged.

CAUTION: Before lifting/hoisting the airframe always clear the immediate area of people and equipment.

To lift the aircraft:

- 1 Position the hoisting/lifting system over the aircraft
- 2 Remove the wing-fuselage joint seal
- 3 Lift and rotate vertically the 4 hoisting brackets (2 each side) mounted at the wing root, in the wing-fuselage joint gap
- 4 Connect hoisting system to the four hoisting brackets and lift the aircraft carefully

NOTE: the lifting point should be positioned in correspondence to aircraft empty C.G. position. See Weight & Balance Report [1]. Try to reposition the lifting point if the aircraft tilts while being lifted.

To lower the aircraft:

- 1 Lower the aircraft carefully to the ground
- 2 Disconnect and remove the hoisting system from the hoisting brackets
- 3 Fold the 4 hoisting brackets inside the wing-fuselage joint gap
- 4 Apply wing-fuselage joint seal



8.8 CLEANING

8.8.1. CLEANING EXTERIOR SURFACES

The airplane should be washed with a mild soap and water. Harsh abrasives or alkaline soaps or detergents could make scratches on painted or plastic surfaces. Cover static ports and other areas where cleaning solution could cause damage. Be sure to remove the static port covers before flight.

NOTE: Prior to cleaning, place the airplane in a shaded area to allow the surfaces to cool.

To wash the airplane, use the following procedure:

- 1 Flush away loose dirt with water
- 2 Apply cleaning solution with a soft cloth, a sponge or a soft bristle
- 3 To remove exhaust stains, allow the solution to remain on the surface
- 4 To remove stubborn grease, use a cloth dampened with degreaser or naphtha
- 5 Rinse all surfaces thoroughly

Any good silicone free automotive wax may be used to preserve painted surfaces. Soft cleaning cloths or a chamois should be used to prevent scratches when cleaning or polishing. A heavier coating of wax on the leading surfaces will reduce the abrasion problems in these areas. Pledge spray is recommended to be applied once the surface is clean and can be used instead of waxing.

Windscreen and Windows

Before cleaning lexan surfaces, rinse away all dirt particles before applying cloth or chamois. Never rub dry lexan. Do not attempt to polish lexan.

CAUTION: Clean windshield and windows only with a solvent free, none abrasive, anti-static cleaner. Do not use gasoline, alcohol, benzene, carbon tetrachloride, thinner, acetone, or glass window cleaning sprays. Use only a nonabrasive cotton cloth or genuine chamois to clean acrylic windows. Pledge spray is, however, recommended to be applied once the windshield is clean.



NOTE: Wiping with a circular motion can cause glare rings. Use an up and down wiping motion to prevent this. To prevent scratching from dirt that has accumulated on the cloth, fold cloth to expose a clean area after each pass.

- 1 Remove grease or oil using a soft cloth saturated mild detergent, then rinse with clean, fresh water
- 2 Using a moist cloth or chamois, gently wipe the windows clean of all contaminants
- 3 Dry the windows using a dry nonabrasive cotton cloth or chamois

8.8.2. CLEANING INTERIOR SURFACES

Windshield and Windows

Never rub dry lexan. Do not attempt to polish lexan.

CAUTION: Clean lexan windows with a solvent free, none abrasive, anti-static acrylic cleaner. Do not use gasoline, alcohol, benzene, carbon tetrachloride, thinner, acetone, or glass window cleaning sprays. Use only a non-abrasive cotton cloth or genuine chamois to clean acrylic windows. Paper towel or newspaper are highly abrasive and will cause hairline scratches.

NOTE: Wiping with a circular motion can cause glare rings. Use an up and down wiping motion to prevent this. To prevent scratching from dirt that has accumulated on the cloth, fold cloth to expose a clean area after each pass.

- 1 Wipe the windows clean with a moist cloth or chamois
- 2 Dry the windows using a dry nonabrasive cotton cloth or chamois

Instrument Panel and Electronic Display Screens

The instrument panel, control knobs, and plastic trim need only to be wiped clean with a soft damp cloth. The multifunction display, primary flight display, and other electronic display screens should be cleaned with LCD Screen Cleaning Solution.

CAUTION: To avoid solution dripping onto display and possibly migrating into component, apply the cleaning solution to cloth first, not directly to the display screen. Use only a lens cloth or nonabrasive cotton cloth to clean



display screens. Paper towels, tissue, or camera lens paper may scratch the display screen. Clean display screen with power OFF.

- 1 Gently wipe the display with a clean, dry, cotton cloth
- 2 Moisten clean, cotton cloth with cleaning solution
- 3 Wipe the soft cotton cloth across the display in one direction, moving from the top of the display to the bottom. Do not rub harshly
- 4 Gently wipe the display with a clean, dry, cotton cloth

The airplane interior can be cleaned with a mild detergent or soap and water. Harsh abrasives or alkaline soaps or detergents should be avoided. Solvents and alcohols may damage or discolor vinyl or urethane parts. Cover areas where cleaning solution could cause damage. Use the following procedure:

- 1 Clean headliner, and side panels, with a stiff bristle brush, and vacuum where necessary
- 2 Soiled upholstery, may be cleaned with a good upholstery cleaner suitable for the material. Carefully follow the manufacturer's instructions. Avoid soaking or harsh rubbing

CAUTION: Solvent cleaners and alcohol should not be used on interior parts. If cleaning solvents are used on cloth, cover areas where cleaning solvents could cause damage.

Leather Upholstery and Seats

Wipe leather upholstery with a soft, damp cloth. For deeper cleaning, use a mix of mild detergent and water. Do not use soaps as they contain alkaline which will cause the leather to age prematurely. Cover areas where cleaning solution could cause damage. Solvent cleaners and alcohol should not be used on leather upholstery.

- 1 Clean leather upholstery with a soft bristle brush and vacuum it
- 2 Wipe leather upholstery with a soft, damp cloth
- 3 Soiled upholstery, may be cleaned with approved products. Avoid soaking or harsh rubbing

Carpets

To clean carpets, first remove loose dirt with a whiskbroom or vacuum. For soiled spots and stubborn stains use a non-flammable, dry cleaning fluid. Floor carpets may be cleaned like any household carpet.

SECTION

9



SECTION 9 – APPENDIX

LIST OF APPENDICES

APPENDIX NO.	APPENDIX
9-A1	EPSI570C SYSTEM DESCRIPTION

APPENDIX

9-A1



SECTION 9 – APPENDIX 9-A1

EPSI570C SYSTEM DESCRIPTION

The EPSI570C is an integrated avionics device which monitors several propulsion system operational parameters on the VELIS Electro. The display informs the user about system status and shows RPM, power controller temperature, motor temperature, coolant temperature, state of charge, battery temperature and state of health. EPSI570C device is installed on the instrument panel of the aircraft. The device is composed of a main display, a selection knob, and a USB port for software updates. The device is operative when the AVIONICS switch is engaged. Rotation of the selection knob allows the user to move from page on the display.

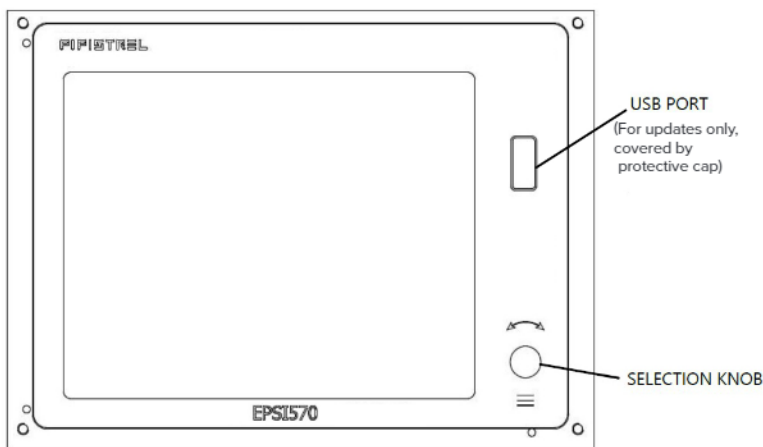

The EPSI570C also contains a small audio speaker, used for audio feedback and alarms. In addition to the speaker, an audio output is also implemented which is connected to the aircraft's audio panel (or radio). EPSI570C communicates with the propulsion system of the VELIS Electro via three CAN-bus interfaces running at 500kBit. It is powered via a standard 10-15V supply rail, which in the VELIS Electro is supplied by the system controller.



Table below gives basic specifications of the EPSI570C instrument.

PARAMETER	VALUE
Size	160 mm × 120 mm × 25 mm
Weight	450 g
IP Class	IP 54
Display	5.7 inch, 640 X 480 (VGA) full color TFT LCD
Communication	3x CAN-bus @ 500kbit/sec
Audio	Built-in speaker + 1 Vpp audio out
USB	1X USB 2.0 full speed compliant USB host
Connector	1x 15-Pin D-Sub
Operating temperature range	-20°C – 75°C
Power supply	10V-15V, 8W max.

The main task of EPSI is to provide essential information of the electric propulsion system to the pilot, which includes:

- Motor operating status, RPM, power and temperature
- Power controller operating status, temperature
- Battery system operating status, temperature, SOC (State of Charge) and SOH (State of Health)
- Remaining Flight Time (RFT) - for information only
- System error, caution and warning messages
- Auxiliary (14V) battery status and voltage

EPSI570C also includes a USB host port on the front side. The USB port is used for aircraft's firmware updates and is covered/protected during normal operations. USB cover removal and software updates are a maintenance tasks are should not be performed by the pilot.



Display Modes

EPSI570C has three different display modes/pages: Flight mode and System mode are used in flight, Charge mode is used on the ground during battery recharge. The transition from a mode to another is done by the selection knob rotation.

NOTE: Values shown in the following pictures are for demonstrative purposes only and do not apply to any specific real operational situation.

FLIGHT page

FLIGHT page mode is the mode used most during flight. It displays the actual operational parameters like RPM and power kW (battery output power). This screen allows the monitoring of component status and temperatures, battery voltage and warning messages as well. See the picture below for a description of FLIGHT mode page.

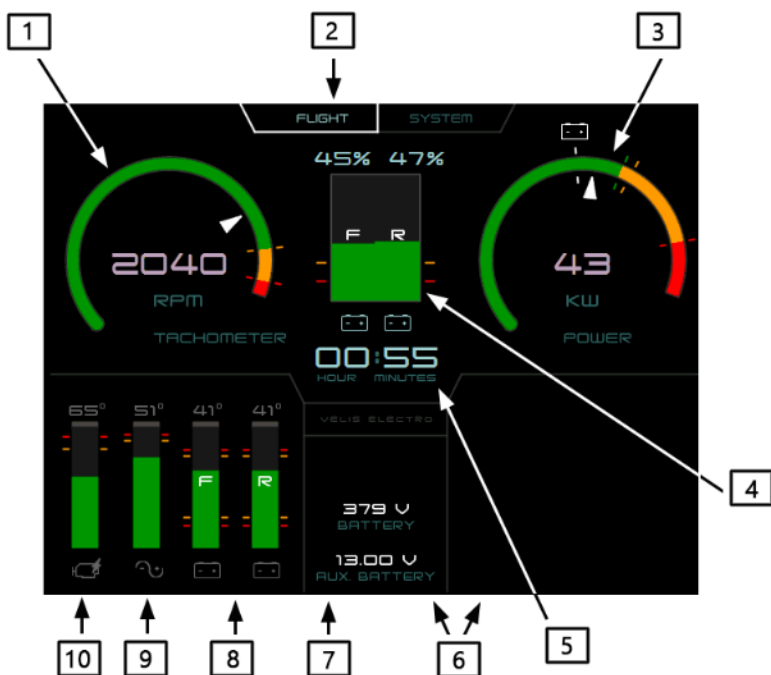



1	RPM indication	6	Warning and Caution sections (when messages are present)
2	Actual menu page	7	HV Battery and aux batt voltage
3	Power indication kW	8	Battery temperatures
4	Battery state of charge (F-R)	9	Power controller temperature
5	Remaining flight time (For information only)	10	motor temperature

EPSI Power indication - presentation details:

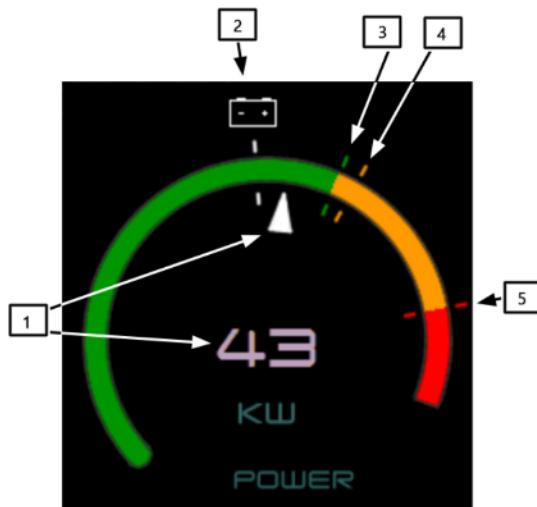

1	Actual power setting
2	Maximum power setting for single battery operation
3	Maximum Continuous Power (MCP)
4	Minimum Performance Take Off Power (MPTOP)
5	Maximum Take off Power (MTOPI)

NOTE: MCP, MPTOP and MTOPI are defined in section 1.7.3.



Examples of parameters in caution or warning range - FLIGHT page:

- Example 1) Temperature in caution or warning range (battery temperature)



- Example 2) RPM and Power indication in caution and warning range

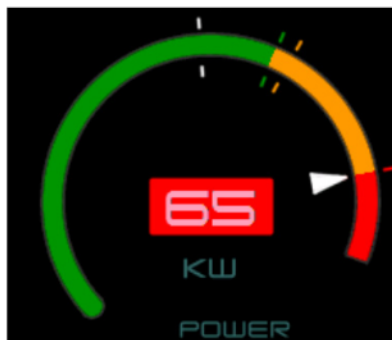

- Example 3) Battery SOC indication in caution range (SOC <30%)





SYSTEM page

SYSTEM page mode shows several diagnostic values of the system components. This mode is selected by rotating the knob.

Some parameters will be displayed on an amber or red background when in caution or warning range (Battery: SOH, Temp, Min volt, Current; Engine: temp m, Temp l).

Refer to the following table for a short description of the parameters.

FLIGHT		SYSTEM	
BATTERY		ENGINE	
Position:	front rear	Status:	active
Status:	Active Active	Temp m:	65°C
SOH:	99 100	Temp l:	51°C
Temp:	41°C 41°C	Coolant:	46°C IN
MIN volt:	4.090V 4.100V	Coolant:	63°C OUT
MAX volt:	4.100V 4.123V	Hobbs:	8h 20min
Voltage:	379V 379V		
Current:	89.0A 75.0A		
Balancing:	off off		
Coolant:	20°C		
POWER LEVER		DC/DC	
Status:	active	Status:	active
Seen zero:	yes	Out volt:	0.5V
		Out curr:	1.0A
		In volt:	369.0V
		In curr:	0.3A

BATTERY section	
One column for each battery	
Parameter	Description
Status:	Battery status ("-" = not connected/not present; ready = connected ; active = connected and power relays closed ; error)
SOH:	State Of Health of the batteries (SOH) (if this parameter is lost due to malfunction, mission can be completed. Contact CAMO/CAO after the flight)



Temp:	Shows the max temp inside the battery pack, detected by the temperature sensors
MIN Volt: MAX Volt:	Minimum and Maximum voltage value of the cells in each battery pack.
Voltage: Current:	Battery packs voltage and current. Negative values possible during charging.
Balancing:	Indicates if cell balancing is active
Coolant:	Temperature of the battery coolant sensor in battery cooling system diagram - Section 7.6.3.

ENGINE section**Power controller and motor**

Parameter	Description
Status:	Status of the power controller
Temp m:	Motor temperature
Temp I	Power controller temperature
Coolant - IN:	Engine coolant temperature - Sensor "coolant cold" in engine cooling system diagram - Section 7.6.3.
Coolant - OUT:	Engine coolant temperature - Sensor "coolant hot" in engine cooling system diagram - Section 7.6.3.
Hobbs:	Hobbs meter of the power controller (Counts the cumulated power controller time - when PWR EN switch is ON. The time does not depend on motor/propeller RPM)

NOTE: If power controller or motor temperature sensor failure occurs, the mission has to be aborted. In this case, Coolant IN and Coolant OUT temperature values (EPSI570C – SYSTEM page) can help the pilot identify engine cooling malfunction if temperatures rise abnormally.

POWER LEVER section**Power lever**

Parameter	Description
Status:	Status of the component.



Seen zero:	yes/no: shows if the power lever has been moved to cut off after battery activation. This is a safety feature. The motor can only be started once power lever has been moved to cut off position.
------------	---

DC/DC section	
DC/DC converter	
Parameter	Description
Status:	Status of the component
Out volt: Out curr:	Voltage and current output of the converter
In volt: In curr:	Voltage and current input to the converter

Examples of parameters in caution or warning range - SYSTEM page:

- Example 1) Motor temperature in caution range, Power controller temperature in warning range:

ENGINE	
Status:	active
Temp M:	100°C
Temp I:	70°C

- Example 2) Front Battery parameters (SOH, temperature, min cell voltage) in caution range:

BATTERY		
Position:	front	rear
Status:	Active	Active
SOH:	10	12
Temp:	52°C	50°C
MIN Volt:	3.100V	3.200V



CHARGE page

CHARGE page mode is active during battery recharge process. It displays the actual charging process parameters in the form of a progress bar (100% is charge completed), temperature of the charger and of the batteries, and charger input/output voltage and current values.

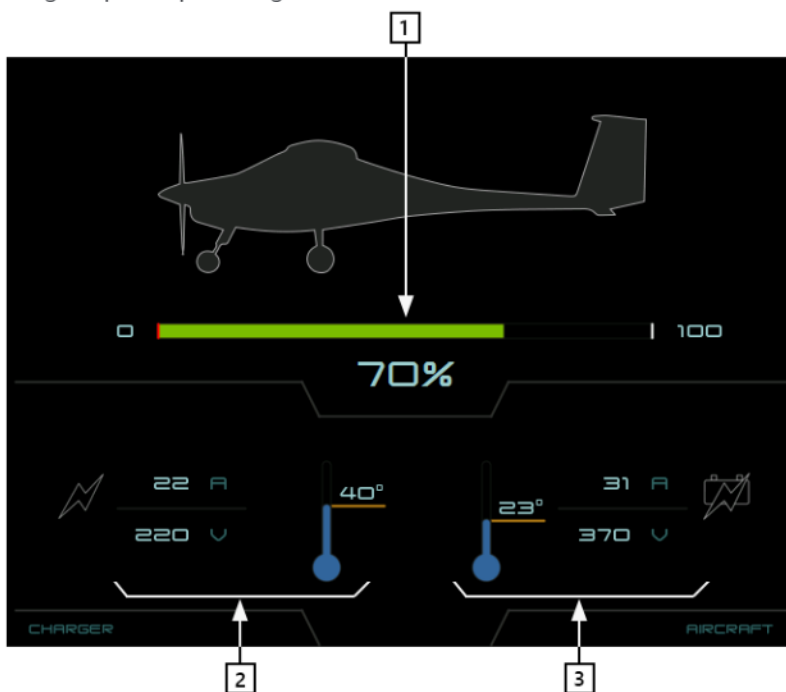

- 1 Charging phase - progress bar %,
- 2 Charger - input parameters: AC current (mains), voltage (mains), charger power module temperature
- 3 Aircraft - battery system parameters: DC input current, charging voltage, battery temperature (highest value measured among all battery temperature sensors).

NOTE: Values in the picture are for illustrative purposes only.



Warning and Caution messages

EPSI570C is used in conjunction with the annunciator panel to display warnings and cautions related to the electric motor, power controller, batteries or other systems. The warning and caution messages are “descriptive”, and provide a basic details of the problem and/or system affected. When a message appears, it is accompanied by an aural warning emitted by the beeper integrated into the annunciator, and is also heard in the headsets. Two areas of the EPSI570C display are used to show the messages.

Central display area

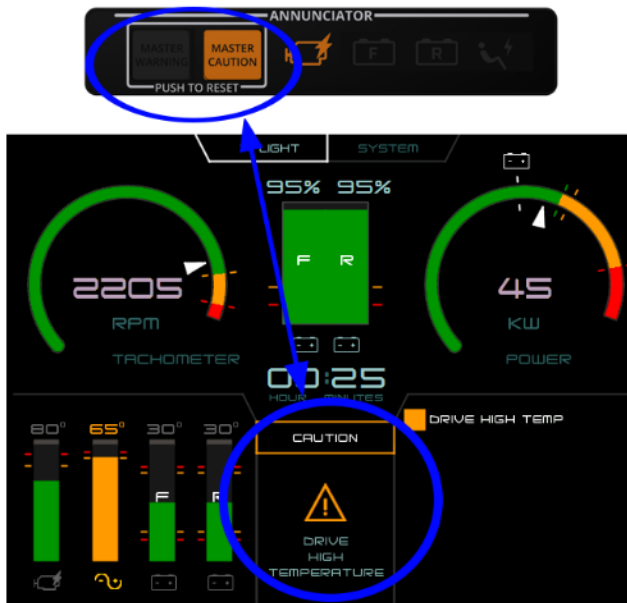

The central display area is used to show the first un-acknowledged warning or caution, in chronological order. Only one single message, is visible at a given time. Warnings have priority over Cautions and override them: a warning message will be displayed even if it happened before a caution. The central area is the most important to check, as it shows the latest and the most important/urgent message. After a message has been acknowledged by pressing the MASTER CAUTION /MASTER WARNING button, this area of the screen will return to the normal status (battery and aux battery voltage), or it will display the next message, if any.



This area of the display is functionally connected to the MASTER CAUTION /MASTER WARNING buttons on the annunciator. The annunciator buttons will be illuminated according to the message category shown on the display.

NOTE: if the pilot is in SYSTEM page, the caution/warning message will appear also in the central area of this page. The pilot has to return to FLIGHT page and continue the message-associated procedure.

The pilot has to perform the corrective action required by the caution or warning. After this action, the pilot can push the button on the annunciator panel to reset and acknowledge the message. If it was the only message present, the MASTER CAUTION or MASTER WARNING light will turn off, and the central display area will be empty. If other messages are present in the background, the display will show the second most recent message (warnings have priority), and annunciator buttons will illuminate accordingly. This sequence will continue until the last message has been acknowledged.

Bottom-right display area





After a message has been acknowledged by pushing the button on the annunciator panel, the message remains visible in the list on the bottom-right area of the EPSI display. A colored square will show the message category (red for warnings, orange for cautions). Messages are presented in chronological order, the latest at the bottom. Warning messages have priority over cautions, and are displayed on top of the list, regardless of the chronological order in respect to cautions.

The list can show up to seven messages, and is functionally connected to the right part of the annunciator panel. System icons will illuminate according to the cautions or warnings which are listed on the EPSI display, and give the pilot an overview of systems that are affected by unresolved issues. When the cause which triggered the caution or the warning disappears or is solved (e.g. high temperature), the message will disappear also from the list (only after being acknowledged by the pilot by pressing the buttons on the annunciator) and the related system icon on the annunciator will turn off.

CAUTION: Do not take off in case any Caution/Warning messages appear on EPSI570C display or annunciator.

CAUTION: Do not take off in case of any missing indication/information field on EPSI570C display or in case any lights/icons fail to illuminate during the system selftest that activated when MASTER switch is turned ON. Contact CAMO/CAO for support.

EPSI570C Warning and Caution messages

NOTE: See Section 3 - Emergency procedures - for the list of EPSI570C warning and caution messages and related emergency procedures.



EPSI display in case of system malfunctions

In case of malfunction or disconnection of a system (e.g. one of the high voltage batteries), its parameters may not be available. Unavailable data will be covered by a red cross, or replaced by "0" value.

EXAMPLE: BATTERY NOT PRESENT (battery loss of communication)

Some emergency procedures may require front (F) or rear (R) high voltage battery manual disconnection. This is accomplished by disengaging its circuit breaker. Beside power transfer interruption (open relay), also data connection with the battery is lost and all its parameters will no longer be available.

The following pictures show EPSI570C display when the communication with the front (F) battery is lost.

Flight page: SOC and temperature of the front battery are not available and covered by a red cross.

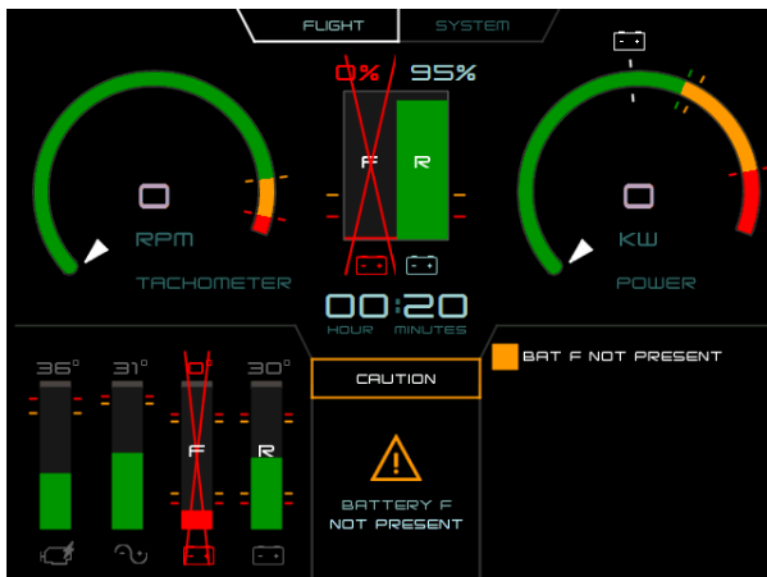



System page: all the parameters of "front" battery are not available.

FLIGHT		SYSTEM	
BATTERY		ENGINE	
Position:	front rear	Status:	active
Status:	- Active	Temp M:	65°C
SOH:	- 100	Temp I:	51°C
Temp:	- 41°C	Coolant:	46°C IN
MIN volt:	- 4.100V	Coolant:	63°C OUT
MAX volt:	- 4.123V	Hobbs:	8h 20min
Voltage:	- 379V		
Current:	- 75.0A		
Balancing:	- OFF		
Coolant:	20°C		
POWER LEVER		DC/DC	
Status:	active	Status:	active
Seen zero:	yes	Out volt:	0.5V
		Out curr:	1.0A
		In volt:	369.0V
		In curr:	0.3A

CAUTION

BATTERY F
NOT PRESENT

NOTE: Caution message in the central display area will disappear from FLIGHT and SYSTEM page after acknowledgment.

EXAMPLE: EPSI LOSS OF COMMUNICATION

The data displayed in the EPSI pages are either lost (battery SOC and temperature) or frozen to the last recorded value (motor and power controller parameters). In addition, the loss of communication EPSI-system controller implies that the EPSI does not display any caution or warning message, with the caution and warning list replaced by a red cross. This behavior is nominal, as cautions and warnings are generated by system controller and only in a subsequent phase sent to the EPSI.

The lack of caution and warning message on the EPSI is balanced by the correct functioning of the annunciator. As additional deficiency, the power indication on the Kanardia instrument shows constantly OkW, because its signal is managed by the system controller (See also Section 3.10 - EPSI570C display failure emergency procedures).



Flight page: Battery parameters not available, caution/warning messages not available, other parameters frozen to the last recorded value.



System page: Battery parameters not available, other parameters frozen.





This page is intentionally left blank.



Pipistrel d.o.o.
Goriška cesta 50a
SI-5270 Ajdovščina
Slovenija - EU
t +386 (0)5 3663 873
f +386 (0)5 3661 263
info@pipistrel.si
www.pipistrel-aircraft.com

Pipistrel Italia
Via Fratelli Rusjan, 26
34070 Savogna d'Isonzo (GO)
Italia - EU
t +39 3703207623
pipistrel@legalmail.it
www.pipistrel-aircraft.com

Pipistrel Vertical Solutions d.o.o.
Vipavska cesta 2
SI-5270 Ajdovščina
Slovenija - EU
t +386 5 366 38 73
f +386 5 366 12 63
info@pipistrel.si
www.pipistrel-aircraft.com